

Cartridge/Insertion Heaters



Cartridge/Insertion Heaters	Sheath Materials	Max. Operating Temperatures		Typical Max. Watt Densities		Page
		°F	°C	W/in ²	W/cm ²	
FIREROD®	Alloy 800	1400	760	400	62.0	9
	Stainless steel	1000	538	400	62.0	
High-Temperature FIREROD	Alloy 800	1600	982	100	15.5	33
Metric FIREROD	Alloy 800	1400	760	330	50.0	45
MULTICELL™	Alloy 800	2050	1120	30	4.6	54

Cartridge/Insertion Heaters





Cartridge/Insertion Heaters



FIREROD® Cartridge Heaters

The Watlow® FIREROD® cartridge heater incorporates engineering excellence and is supported by over 60 years of solid industry performance across a broad range of simple and complex applications. As the premier choice in swaged cartridge heating, thousands of industrial manufacturers continue to choose Watlow as their trusted thermal partner and certified cartridge heater supplier.

Built using premium materials and tight manufacturing controls, the FIREROD heater provides superior heat transfer, uniform temperatures, resistance to oxidation and corrosion and a long life even at high temperatures. Every system component that leaves our manufacturing facilities meets our strict quality assurance specifications, in addition to those set forth by leading standards and regulating industries.

To meet our customer's individual needs, there are many delivery options available for FIREROD heaters.

Performance Capabilities

- Part temperatures up to 1400°F (760°C) on alloy 800 sheath
- Watt densities up to 400 W/in² (62 W/cm²)
- Maximum voltage up to 480V

Features and Benefits

Nickel-chromium resistance wire

- Ensures even and efficient distribution of heat to the sheath

Metalurgically-bonded conductor pins

- Ensures a trouble-free electrical connection

Magnesium oxide insulation of specific grain and purity

- Results in high dielectric strength and contributes to faster heat-up

Alloy 800 sheath

- Resists oxidation and corrosion from heat, many chemicals and atmospheres

Minimal spacing between the element wire and sheath

- Results in lower internal temperature
- Accommodates a design with fewer or smaller heaters operating at higher watt densities

International Organization for Standardization (ISO) 9001 certified

- Provides confidence that quality and reliability expectations are met

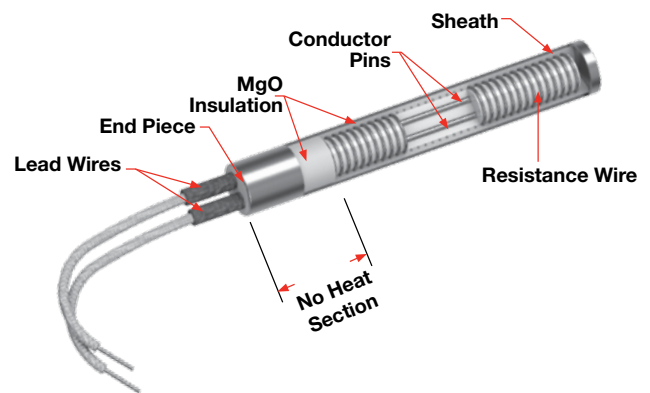

UL® and CSA approved flexible stranded wires

- Lead insulation rated to temperatures up to 840°F (450°C)

Patented lead adapter (LA) method

- Allows same day shipment on more than 150,000 configurations of stock FIREROD heaters and lead combinations

Typical Applications

- Semiconductor chamber heating
- Semiconductor wire and die bonding
- Freeze protection and deicing of equipment in cold climates or applications
- Humidity control
- Patient comfort heating used in medical devices
- Mold die and platen heating
- Seal bars used in packaging equipment
- Test sample heating in gas chromatography equipment
- High temperature glass forming equipment

Cartridge/Insertion Heaters



FIREROD Cartridge Heaters

Applications and Technical Data

Tolerances

Diameter

- 1 in. (25 mm) units: ± 0.003 in. (± 0.08 mm)
- All other units: ± 0.002 in. (± 0.05 mm)

Sheath Length

- All units up to 4¹/₂ in. (114 mm) long: ± 3 /₃₂ in. (± 2.4 mm)
- 1/8 in. diameter units over 4¹/₂ in. (114 mm) long: $\pm 3\%$
- All other units over 4¹/₂ in. (114 mm) long: $\pm 2\%$

Length Measurements

Pin Style and Potted FIRERODs

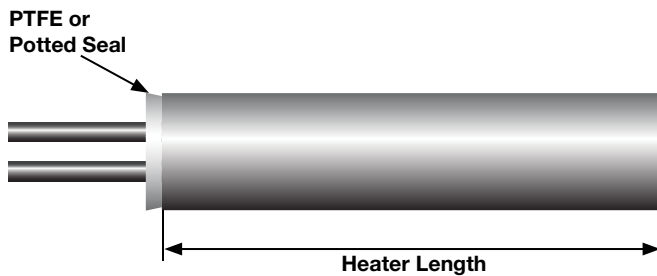

PTFE - Swaged-in Leads FIRERODs

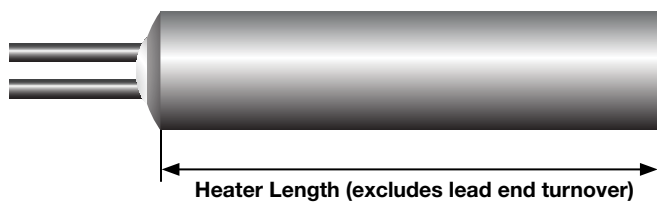

Wattage

- 1/8 in. units: +10%, -15%
- All other units: +5%, -10%

Resistance

- 1/8 in. units: +15%, -10%
- All other units: +10%, -5%

Resistance changes with temperature. There are three circumstances under which resistance can be measured:

1. Room temperature (before use): nominal ohms are approximately 90% of Ohm's law calculation.
2. Room temperature (after use): nominal ohms are approximately 95% of Ohm's law calculation.
3. At temperature (during use): depending on application nominal ohms are approximately 100% of Ohm's law.

Note: Resistance and wattage values are approximate depending on application conditions.

Component Recognition File Numbers

- UL[®] component rated to 240VAC (file number E52951)
- CSA component rated to 240VAC (file number LR7392)
- VDE component rated to 240VAC (file number 1164800-4911-0009) (file number 1164800-4911-0004)

Note: Not all options or combinations of options are covered. UL[®], CSA, VDE and CE marking is available upon request.

Cartridge/Insertion Heaters



FIREROD Cartridge Heaters

Applications and Technical Data

Dimensional Data

This table shows minimum/maximum sheath lengths for available FIREROD diameters.

FIREROD Diameter			Length			
Nominal in.	Actual in.	(mm)	Min. in.	(mm)	Max. in.	(mm)
1/8	0.122	(3.1)	7/8	(22.2)	12	(305)
1/4	0.246	(6.3)	7/8	(22.2)	36	(915)
3/8	0.371	(9.4)	7/8	(22.2)	48	(1220)
1/2	0.496	(12.6)	7/8	(22.2)	60	(1520)
5/8	0.621	(15.8)	1	(25.0)	72	(1830)
3/4	0.746	(18.9)	1	(25.0)	72	(1830)
1	0.996	(25.3)	1 1/4	(32.0)	72	(1830)

Indicates **recommended** maximum sheath length; however, longer lengths may be available.

Camber

Camber is defined as the maximum deviation of the heater's center line from straight. FIREROD camber within allowable tolerances is verified via passage through a cylindrical gauge of specified length and diameter. Normally, slight camber does not present a problem since the heater will flex enough to fit into a straight, close-fit hole.

Camber Measurement

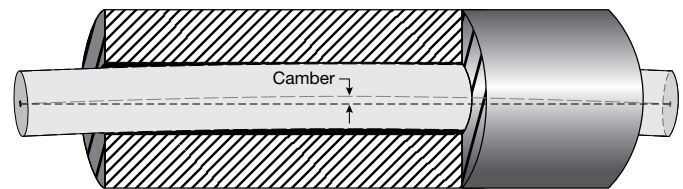

Allowable Camber Versus Length

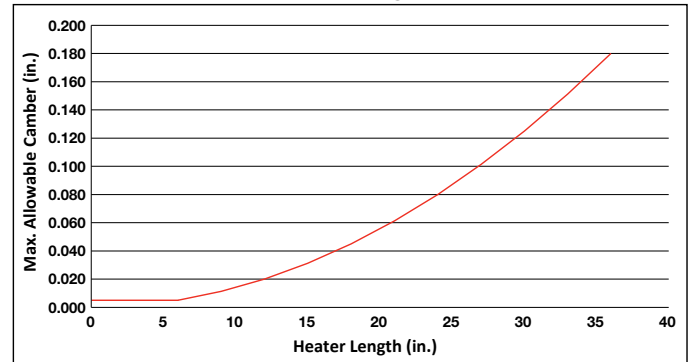

Max. camber = 0.020 in. x (length in feet)² or 0.005 in., whichever is greater.

Cartridge/Insertion Heaters



FIREROD Cartridge Heaters

Applications and Technical Data (Continued)

Electrical Data

The table below will assist you in selecting the correct FIREROD heater for your application, according to available voltage, amperage and wattage.

Please note, some combinations of minimum and maximum wattages are not available on the same heater diameter. If your application exceeds the limitations shown, contact your Watlow representative.

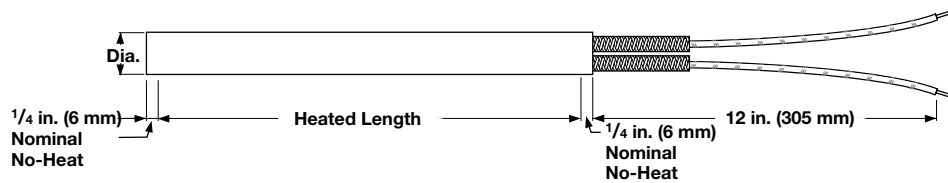

Crimped on Lead Termination Shown

FIREROD Diameter in.	Volts Max.	Ampere Max. ^①	Min. Watts @ 120V ^③ Heater Length			Max. Watts				
			1 in. (25 mm)	1 1/2 in. (38 mm)	2 in. (50 mm)	120V 1-phase	240V 1-phase	480V 1-phase	240V 3-phase	480V 3-phase
1/8	240	3.1	—	8	5	360	720	—	—	—
1/4	240	4.4 ^②	100	55	40	525	1050	—	—	—
3/8	240	6.7	65	35	25	800	1600	—	—	—
1/2	240	9.7	40	25	20	1160	2320	—	—	—
5/8	480	23.0	35	20	15	2760	5520	11,000	⑤	⑤
3/4	480	23.0	30	15	10	2760 ^④	5520	11,000	9550	19,100
1 ^⑦	480	23.0	—	15	10	2760 ^④	5520	11,000	9550 ^④	19,100 ^④

Number Of Circuits ^⑥		
Diameter in.	1-phase	3-phase
3/4	3	1
1	5	2

- ① Determined by the current carrying capacity of internal parts and lead wire. Alternate material may be available.
- ② For 1/4 in. (6 mm) units with thermocouple maximum amperage is 3.1A.
- ③ Determined by the limitation of space for resistance winding. For minimum wattage of 240VAC multiply value by four.
- ④ Higher wattages are available using more than one set of power leads. Multiply the wattage from the table by the applicable factor.
- ⑤ Contact your Watlow representative for data.
- ⑥ On 3/4 in. (19 mm) diameter units, either three single-phase circuits or one three-phase delta or wye circuit is available. On 1 in. (25 mm) diameter units, either five single-phase or two three-phase delta circuits are available.
- ⑦ A minimum charge per line item applies.

Cartridge/Insertion Heaters



FIREROD Cartridge Heaters

Maximum Allowable Watt Density

The following four charts detail maximum allowable watt densities for applications that use metal, steam, air or gas heating. Please review the charts and applicable data to determine the correct watt density for your application.

Correction Factors

These graphs depict FIRERODs used in steel parts, therefore, for stainless steel, aluminum or brass, refer to applicable correction factors:

1. For stainless steel, enter the graph with a fit 0.0015 in. (0.04 mm) larger than actual fit.
2. For aluminum and brass, enter the graph with a temperature 100°F (38°C) above actual temperature.

Heating Metals

The *Maximum Watt Density— Heating Metals* chart will display the maximum hole fit or recommended watt density of the heater. Enter the chart with either known variable, part-fit-in-hole dimension or W/in². Then, find the application temperature by reading up or over on the chart.

If the fit of the heater in the hole dimension is not known, it can be easily determined. Subtract the minimum diameter of the FIREROD (nominal diameter minus tolerance) from the maximum hole diameter. For example, the hole fit is 0.006 in. (0.15 mm) for a hole diameter of 0.500 in. (13 mm) minus a heater diameter of 0.496 in. (12.6 mm) ±0.002 in. (0.05 mm). For FIREROD heaters in square holes or grooves, contact your Watlow representative for the fit in hole dimension.

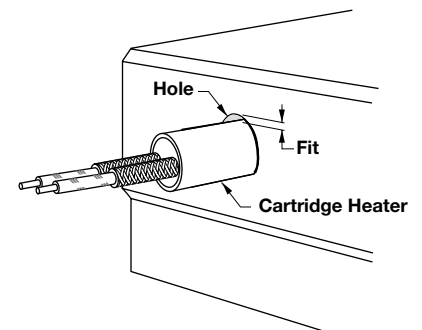
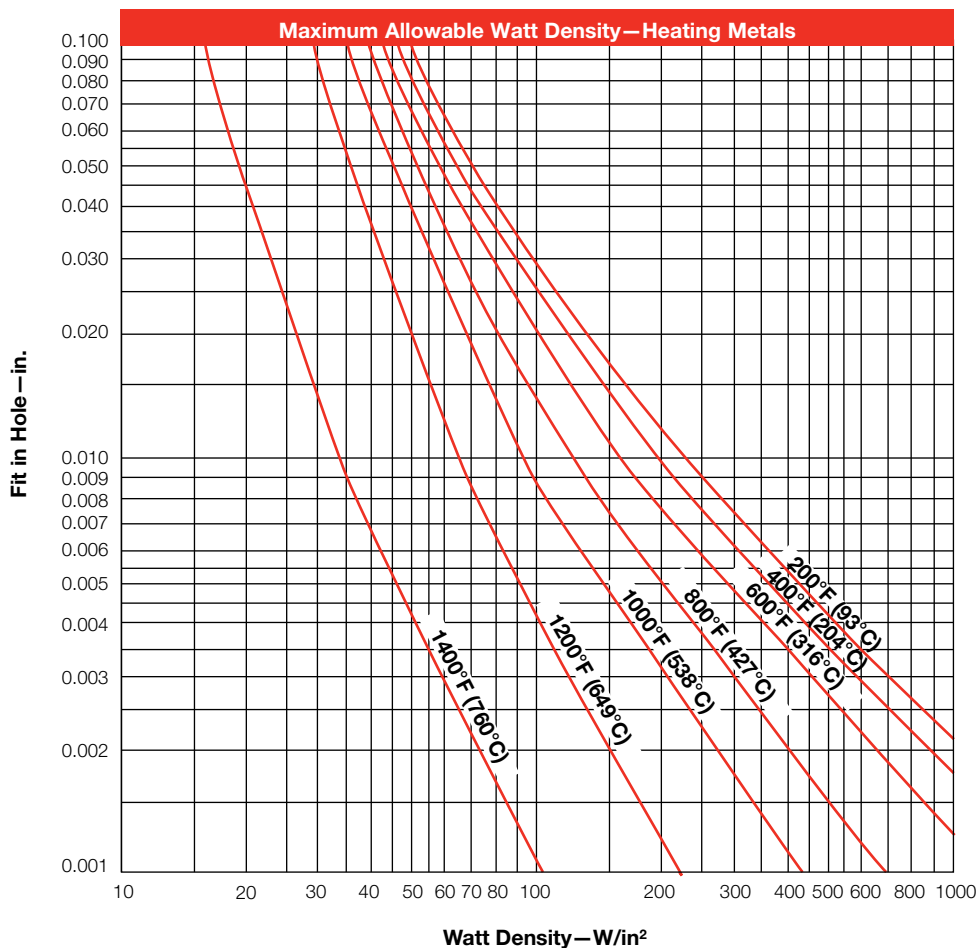

Fit in hole = maximum hole I.D. minus minimum heater O.D.



FIREROD Cartridge Heaters

Maximum Allowable Watt Density (Continued)

Watt Density vs. Ambient Air Temperature

The *Watt Density vs. Ambient Air Temperature* graph shows the maximum allowable watt density when one FIREROD is operated in air or similar gas.

For FIRERODs grouped in a single row, with no less than one diameter between elements, multiply value from the graph by 0.95. When a reflector is placed behind the heaters, multiply the maximum allowable watt density value from the graph by 0.85.

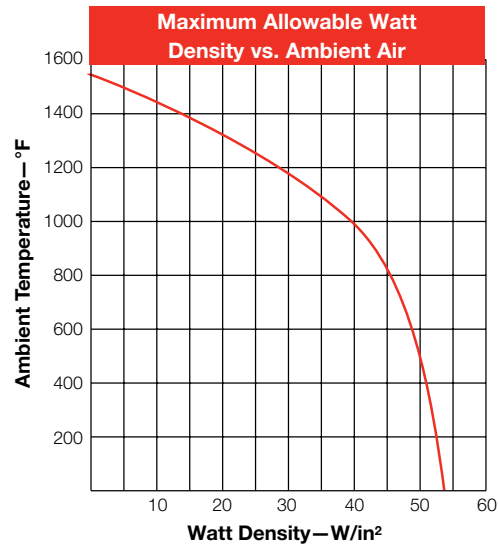

Sheath Temperature in Ambient Air

The *Sheath Temperature in Ambient Air* graph indicates the watt density required to bring a pre-oxidized FIREROD to a given sheath temperature when operated in 70°F (21°C) ambient air.

At 44 W/in² (6.8 W/cm²), the sheath temperature is 1450°F (784°C). At this temperature, a one-year life is expected if cycling is not too frequent.

Higher temperatures result in reduced heater life.

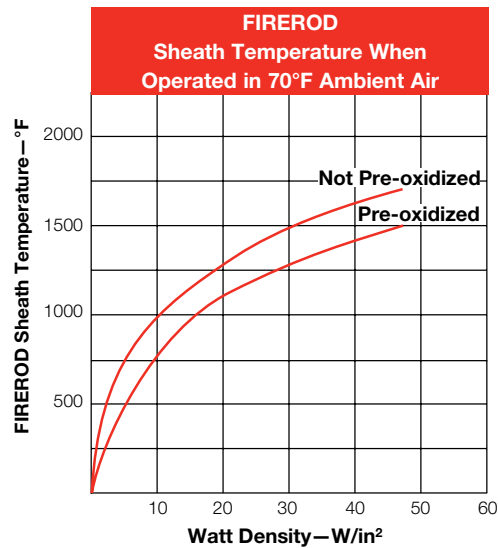

Watt Density in Moving Air

The *Watt Density in Moving Air* graph shows the maximum allowable watt density of a FIREROD in moving air.

The air movement is expressed in feet per minute (FPM). If the air flow is known in cubic feet per minute (CFM), divide the CFM by the net-free area around the heater (ft²). The net-free area is the total area of the enclosure minus the area occupied by the heater.

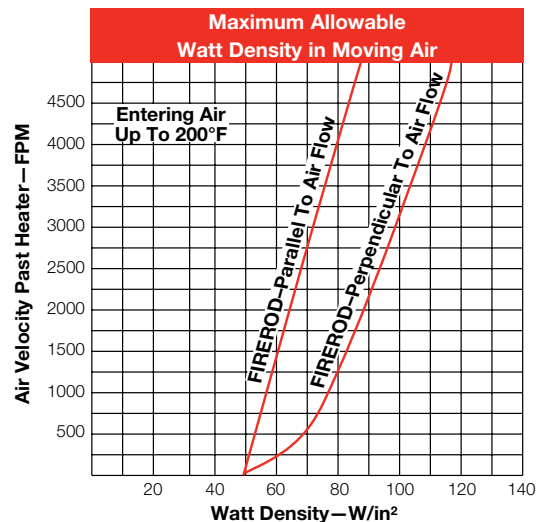

Cartridge/Insertion Heaters



FIREROD Cartridge Heaters

Lead and Diameter Information

Standard Lead Specifications

Heater Diameter in. (mm)	Max. Voltage	Typical Lead Gauge Fiberglass	Size Tolerance Fiberglass	Typical Lead Gauge PTFE	Size Tolerance PTFE	Stainless Steel Hose I.D.	Stainless Steel Braid I.D.
1/8 (3)	300	24	0.044 - 0.058	24 solid	0.036 - 0.044	1/8	1/8
1/4 (6)	300	22	0.066 - 0.078	22	0.050 - 0.058	5/32	1/8
3/8 (10)	300	22	0.076 - 0.088	20	0.056 - 0.064	7/32	3/16
1/2 (13)	300	18	0.089 - 0.101	18	0.074 - 0.084	9/32	1/4
5/8 (16)	600	18	0.108 - 0.124	18	0.097 - 0.113	7/16	3/8
3/4 (19)	600	18	0.108 - 0.124	14	0.097 - 0.113	7/16	3/8
1 (25)	600	18	0.095 - 0.109	14	0.087 - 0.101	N/A	N/A

Lead length tolerances:

1 to 36 in. (25 to 914 mm) = -1/2 in. (13 mm), +1 1/2 in. (38 mm)
 > 36 to 76 in. (914 to 1930 mm) = -1, +3 in. (-25 + 76 mm)
 > 76 in. (1930 mm) = ±4 in. (102 mm)

Stainless steel hose and braid tolerances: same as lead wire.

Units constructed with 480V require MGT or PTFE leads. If connecting heaters in series above 300V, MGT leads are also required.

Ratings: GGS, 300V, 482°F (250°C)
 MGT, 300V/600V, 842°F (450°C)
 PTFE, 300V/600V, 392°F (200°C)
 Silicone rubber, 600V, 302°F (150°C)

Additional Lead Specifications

Lead Gauge	Nickle Ampacity	N.C.C. Ampacity	SPC/NPC
26	2.5	4.2	6.0
24 stranded	3.1	5.2	7.5
24 solid	3.1	5.2	7.5
22	4.4	7.2	10.5
20	N/A	N/A	14.0
18	7.6	12.6	18.0
16	9.7	16.1	23.0
14	12.5	21.0	30.0
12	16.8	28.0	40.0
10	23.0	38.5	55.0

N.C.C. = Nickle-clad Copper

SPC = Silver Plated Copper

NPC = Nickle Plated Copper

GGS or MGT Fiberglass insulated leads are not carried by Watlow as SPC or NPC. Only Nickle or N.C.C.

Cartridge/Insertion Heaters



FIREROD Cartridge Heaters

Lead Adapter (LA)

Options

Patented LA Modification Method

The lead adapter (LA) modification process is a powerful tool for providing a wide range of finished heater configurations very quickly. The LA process allows the base FIREROD heater to be modified into a multitude of configurations. The base FIREROD heater can be selected to meet customers' individual needs. The base heater can then be customized by adding various finishing options like lead length, lead protection, flanges, locating rings and right-angle constructions.

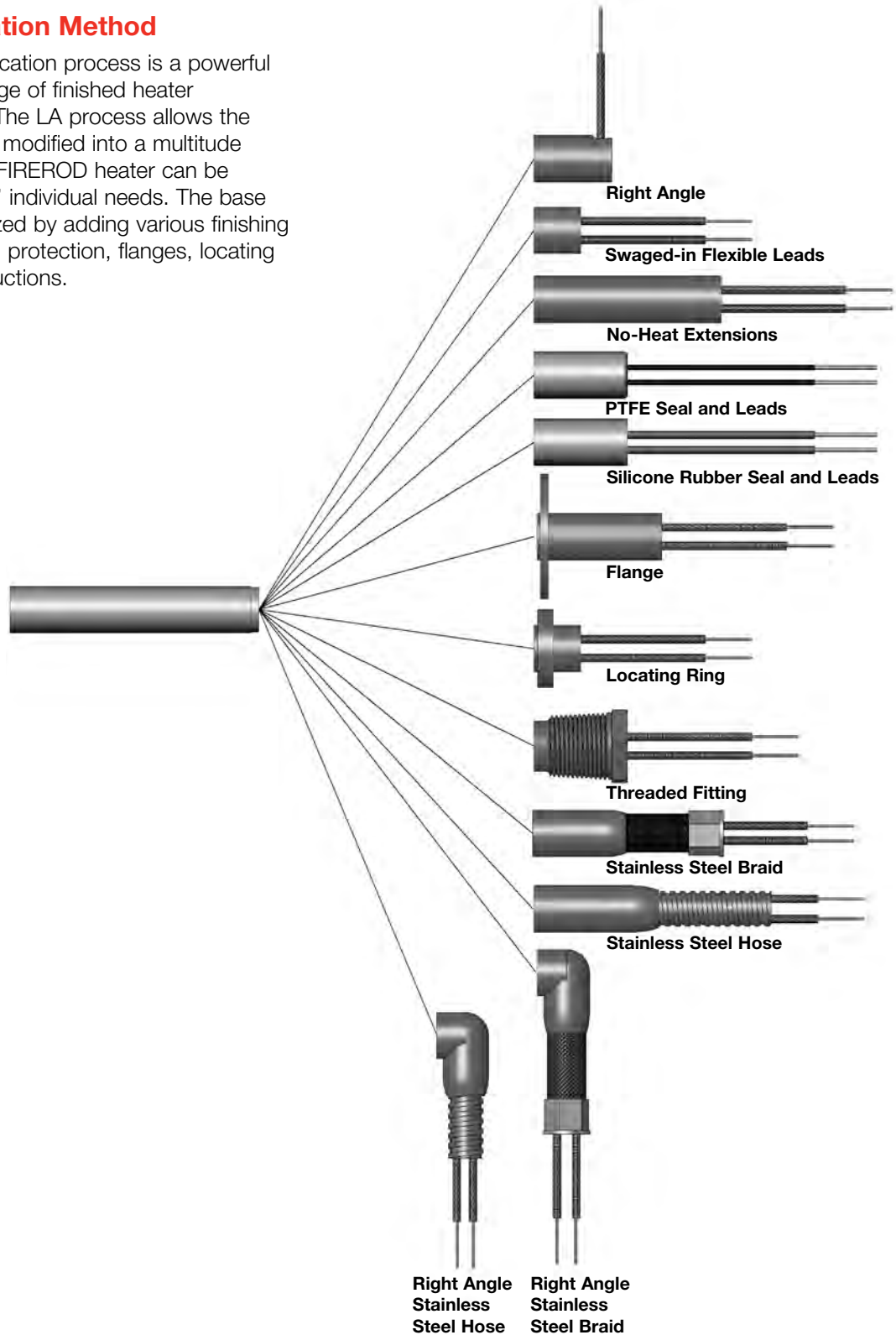

Cartridge/Insertion Heaters



FIREROD Cartridge Heaters

LA

Options (Continued)

Modifying Basic FIRERODs Using the LA Process for Swaged-in Leads

Watlow:

- Shortens conductor pins
- Welds lead wires to pins
- Places an LA cap over the lead end of the heater
- Reduces the diameter of the LA cap over the lead end of the base unit to produce a rugged integrated heater assembly

Notes:

- Other LA construction options use a similar modification process
- Maximum temperature of LA cap is 1000°F (538°C)

Length Tolerance for Stock Heaters With LA Options

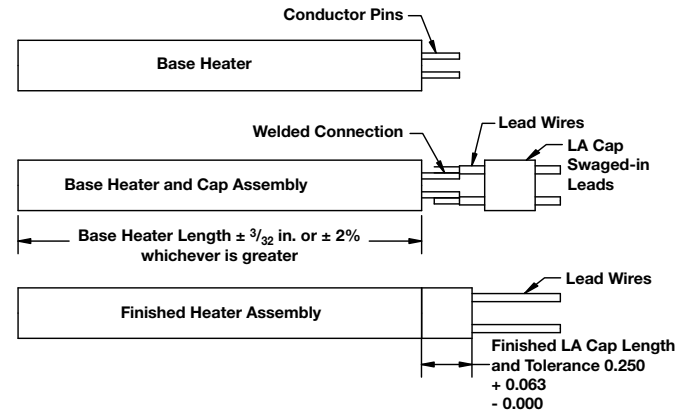

Note: Base heater tolerance + LA cap tolerance = total tolerance for assembly

Termination Options

LA Swaged-in Flexible Leads

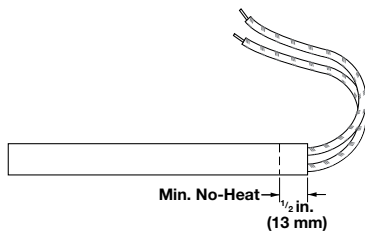

LA swaged-in flexible leads are used in applications where a high degree of flexing exists or the leads must be bent sharply adjacent to the heater without exposing or breaking the conductor. The stranded wire leads are connected internally and exit through the lead end. The overall length of the heater is extended by 1/4 in. (6 mm). To order, specify **length adder code E** bringing the total lead end no-heat to 1/2 in. (13 mm).

This LA option is not available on 1/8 in. (3 mm) diameter FIRERODs. On 1/8 in. (3 mm) diameter FIRERODs, leads are connected externally using a solid conductor lead wire. If stranded wire is desired on 1/8 in. (3 mm) diameter units, contact your Watlow representative.

No-Heat Extensions

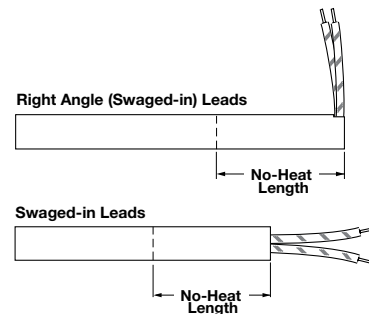

No-heat extensions are recommended in applications where leads may be exposed to excessive heat and require a cooler lead end. They are also used when heat is not required along the entire length of the FIREROD.

No-heat extensions are available for most LA options in diameters of 3/8, 1/2, 5/8 and 3/4 in. (10, 13, 16 and 19 mm). These extensions are designed to provide a total no-heat length of 1, 1 1/2, 2 or 2 1/2 in. (25, 38, 51 or 65 mm) at the lead end of FIRERODs only. Contact your Watlow representative for available LA options.



FIREROD Cartridge Heaters

LA

Termination Options *(Continued)*

LA Straight Stainless Steel Braid

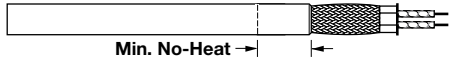

The LA straight stainless steel braid is designed to protect leads from abrasion against sharp edges. It is the most flexible Watlow protective lead arrangement.

Unless specified, a 12 in. (305 mm) braid is supplied. Leads are 2 in. (51 mm) longer than the braid, but longer leads are available.

The minimum lead end no-heat required is $\frac{3}{4}$ in. (19 mm). This option adds $\frac{1}{2}$ in. (13 mm) to the overall length. To order, specify **option code C**.

LA Straight Stainless Steel Hose

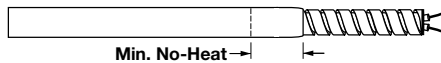

An LA straight stainless steel hose provides the best protection against abrasion from sharp edges. It also offers ease of handling and wiring in abrasive environments. Unless specified a 12 in. (305 mm) hose is supplied. Leads are 2 in. (51 mm) longer than the hose but, longer leads are available.

The minimum lead end no-heat required is $\frac{3}{4}$ in. (19 mm). This option adds $\frac{1}{2}$ in. (13 mm) to the overall length. To order, specify **option code H**.

LA Straight Stainless Steel Hose with PTFE Leads and Seal



An LA straight stainless steel hose with PTFE leads and seal is the ultimate combination for providing abrasion protection and a moisture resistant seal. Unless specified, a standard 12 in. (305 mm) hose is supplied. Leads are 2 in. (51 mm) longer than the hose, but longer leads are available. This seal is effective up to 392°F (200°C) under continuous operation.

The minimum lead end no-heat required is 1 in. (25 mm). This option adds $\frac{3}{4}$ in. (19 mm) to the overall length. To order, specify **option code G**.

LA Silicone Rubber Seal and Leads

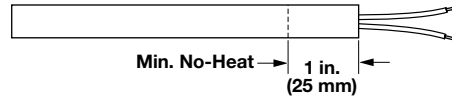

The LA silicone rubber seal and leads protect the heater against moisture and contamination from lubricating oil, cleaning solvents, plastic material, fumes and organic tapes. This seal is effective to 302°F (150°C) under continuous operation.

Please note when ordering this option, that a minimum no-heat section is required to allow for construction. Additional no-heat may be required to keep the seal below effective temperatures. The minimum lead end no-heat required is 1 in. (25 mm). The LA cap adds $\frac{3}{4}$ in. (19 mm) to the overall length. To order, specify **option code P**.

LA PTFE Seal and Leads

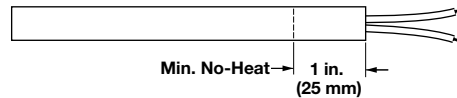

The LA PTFE seal and leads protect the heater against moisture/contamination from lubricating oil, cleaning solvents, plastic material or fumes and organic tapes. This seal is effective to 392°F (200°C) under continuous operation.

Please note when ordering this option, that a minimum no-heat section is required to allow for construction. Additional no-heat may be required to keep the seal below effective temperatures. The minimum lead end no-heat required is 1 in. (25 mm). The LA cap adds $\frac{3}{4}$ in. (19 mm) to the overall length of the heater. To order, specify **option code T**.

LA Straight Stainless Steel Braid with PTFE Leads and Seal

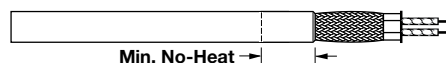

The LA straight stainless steel braid with PTFE leads and seal is Watlow's most flexible lead protection with a moisture resistant seal. Unless specified, a 12 in. (305 mm) braid is supplied. Leads are 2 in. (51 mm) longer than the braid, but longer leads are available. This seal is effective up to 392°F (200°C) under continuous operation.

The minimum lead end no-heat required is 1 in. (25 mm). This option adds $\frac{3}{4}$ in. (19 mm) to the overall length. To order, specify **option code F**.

Cartridge/Insertion Heaters



FIREROD Cartridge Heaters

LA

Right Angle Options

LA Right Angle Leads



LA right angle leads are used in applications with a high degree of flexing and when space limitations are critical. Stranded lead wires are connected internally (swaged-in) and exit at a 90 degree angle at the end of the heater.

To order, specify **option code R**.

Minimum No-Heat Required in. (mm)					
Dia.	1/4	3/8	1/2	5/8	3/4
In. (mm)	13/16 (21)	3/4 (19)	13/16 (21)	13/16 (21)	13/16 (21)

To order right angle leads with PTFE leads and seals, specify **option code B**.

LA Right Angle Stainless Steel Hose

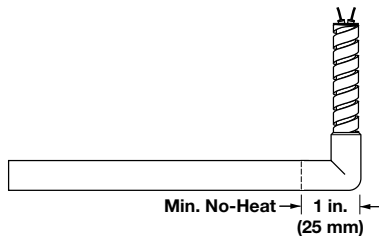

The diameter of the right angle extension is equal to the nominal diameter of the heater.

An LA right angle stainless steel hose is provided for wiring convenience. Like the LA straight stainless steel hose, it protects leads from abrasion against sharp edges. Unless specified, a 12 in. (305 mm) hose is supplied. Leads are 2 in. (51 mm) longer than the hose, but longer leads are available.

Diameter	3/8	1/2	5/8	3/4
Adder length in. (mm)	3/4 (19)	3/4 (19)	3/4 (19)	7/8 (22)
Min. no-heat in. (mm)	1 (25)	1 (25)	1 (25)	1 1/8 (29)

To order specify **option code W**.

Note: This option is not available on 1/4 in. (6 mm) diameter.

LA Right Angle Stainless Steel Hose with PTFE Leads and Seal

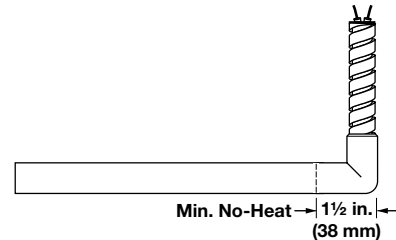

The diameter of the right angle extension is equal to the nominal diameter of the heater.

An LA right angle stainless steel hose with PTFE leads and a seal is the ultimate combination for providing abrasion protection and a moisture resistant seal with wiring convenience. Unless specified, a 12 in. (305 mm) hose is supplied. Leads are 2 in. (51 mm) longer than the hose but longer leads are available. This seal is effective to 392°F (200°C) under continuous operation.

The minimum lead end no-heat required is 1 1/2 in. (38 mm). This option adds 1 1/4 in. (32 mm) to overall length on stock units.

To order, specify **option code M**.

Note: This option is not available on 1/4 in. (6 mm) diameter.



FIREROD Cartridge Heaters

LA

Right Angle Options (Continued)

LA Right Angle Stainless Steel Braid

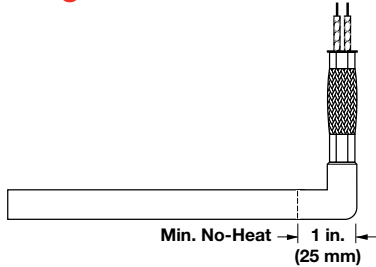

The diameter of the right angle extension is equal to the nominal diameter of the heater.

An LA right angle stainless steel braid is provided for wiring convenience. It protects leads from abrasion against sharp edges.

Unless specified, a 12 in. (305 mm) braid is supplied. Leads are 2 in. (51 mm) longer than the braid, but longer leads are available.

Diameter	3/8	1/2	5/8	3/4
Adder length in. (mm)	3/4 (19)	3/4 (19)	3/4 (19)	7/8 (22)
Min. no-heat in. (mm)	1 (25)	1 (25)	1 (25)	1 1/8 (29)

To order, specify **option code Y**.

Note: This option is not available on 1/4 in. (6 mm) diameter.

LA Right Angle Stainless Steel Braid with PTFE Leads and Seal

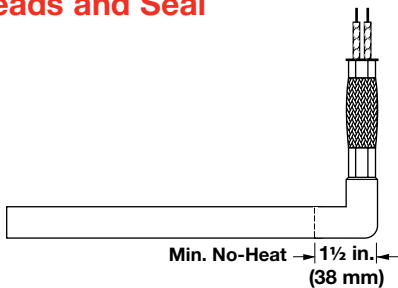

The diameter of the right angle extension is equal to the nominal diameter of the heater.

The LA right angle stainless steel braid with PTFE leads and seal is Watlow's most flexible lead protection with a moisture resistant PTFE seal and wiring convenience. Unless specified, a 12 in. (305 mm) braid is supplied. Leads are 2 in. (51 mm) longer than the braid, but longer leads are available. This seal is effective up to 392°F (200°C) under continuous operation.

The minimum lead end no-heat required is 1 1/2 in. (38 mm). This option adds 1 1/4 in. (32 mm) to the overall length on stock units.

To order, specify **option code A**.

Note: This option is not available on 1/4 in. (6 mm) diameter.

Mounting Options

LA Stainless Steel Threaded Fittings

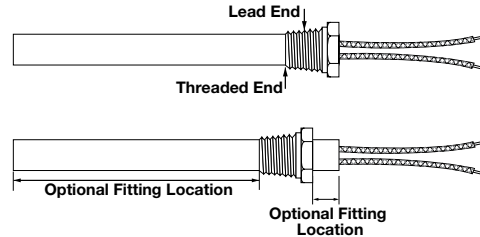

Fitting overlaps the unheated section and is silver soldered to the sheath.

Threaded fittings allow fast, water-tight installation of the heater into a threaded hole. These fittings are 304 stainless steel, other stainless steel alloys are available upon request. Double threaded fittings are also available. Please see page 27 for threaded fitting specifications. Provide the location of the fittings if no-heat extension option is requested.

Lead Arrangement	Minimum Distance ^① Between Threaded End and Lead End	
	in.	(mm)
Crimped Leads	1/4	(6)
Swaged-in Leads	5/16 ^{②④}	(8)
STR SS Hose	1/2 ^③	(13)
STR SS Braid	1/2	(13)
PTFE Seal & Leads	7/8	(22)
Silicone Seal & Leads	7/8	(22)

① The location of the threaded fitting from the thread end of the fitting to the lead end of the heater.

All optional fitting locations are available only with LA no-heat extensions. Contact your Watlow representative for details.

② On 1/4 in. diameter FIREROD only "A" dimension is 7/16 in. (11.1 mm).

③ On 1/4 in. diameter FIREROD only "A" dimension is 5/8 in. (15.9 mm).

④ On 5/8 in. and 3/4 in. the fitting is located at 7/8 in. from the lead end using a 3/4 in. no-heat extension. In order to locate at 5/16 in., the fitting must be epoxied.

Note: Minimum distance between threaded end and heated section is 1/4 in.

Cartridge/Insertion Heaters



FIREROD Cartridge Heaters

LA

Mounting Options *(Continued)*

Flanges

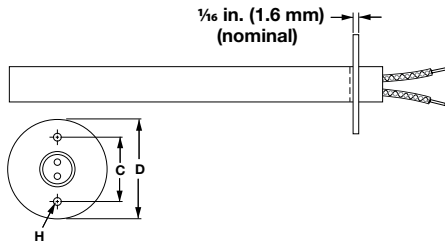

Stainless steel flanges are a convenient mounting method to position a heater within an application. The flange is staked on and located 1/4 in. (6 mm) from the lead end. The flange can be located up to 2 1/4 in. (57 mm) from the lead end if it is over a no-heat section. Use this option in combination with most LA configurations.

To order, specify **flange**, size and locations.

Flange Specifications

FIREROD Diameter in.	Flange Size	in. (mm)		
		D	C	H
1/4, 3/8, 1/2	FS	1 (25)	3/4 (19)	0.144 (4)
1/4, 3/8, 1/2 5/8, 3/4	FM	1 1/2 (38)	1 1/8 (29)	0.156 (4)
5/8, 3/4	FL	2 (51)	1 1/2 (38)	0.201 (5)

Locating Ring

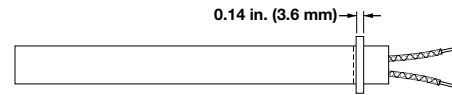

A stainless steel locating ring can be used as a retaining collar to position a FIREROD if mounting requirements are not critical.

For LA, specify the location if the no-heat extension option is requested. On FIRERODs with crimped on leads without the LA option, the locating ring will be located on the last 1/4 in. (6 mm).

To order, specify **locating ring**.

Locating Ring Specifications

Diameter	1/4	3/8	1/2	5/8	3/4
Ring O.D. in. (mm)	1/2 (13)	5/8 (16)	3/4 (19)	7/8 (22)	1 (25)

Cartridge/Insertion Heaters



FIREROD Cartridge Heaters

LA

LA Options

Option	Minimum Length Adders Per Diameter Per Option in. (mm)					Option Code
	1/4 (6)	3/8 (9.5)	1/2 (13)	5/8 (15.9)	3/4 (19)	
Heater Diameter						
Swaged-in leads	E 1/4 (6)	E 1/4 (6)	E 1/4 (6)	E 1/4 (6)	E 1/4 (6)	None
Right angle leads	K 9/16 (14)	J 1/2 (13)	K 9/16 (14)	K 9/16 (14)	K 9/16 (14)	R
PTFE seal and leads	— —	N 3/4 (19)	N 3/4 (19)	N 3/4 (19)	N 3/4 (19)	T
Right angle PTFE seal and leads	— —	N 3/4 (19)	N 3/4 (19)	N 3/4 (19)	N 3/4 (19)	B
Silicone seal and leads	— —	N 3/4 (19)	N 3/4 (19)	N 3/4 (19)	N 3/4 (19)	P
Straight hose	J 1/2 (13)	J 1/2 (13)	J 1/2 (13)	J 1/2 (13)	J 1/2 (13)	H
Right angle hose	— —	N 3/4 (19)	N 3/4 (19)	N 3/4 (19)	R 7/8 (22.2)	W
Straight hose with PTFE seal and leads	— —	N 3/4 (19)	N 3/4 (19)	N 3/4 (19)	N 3/4 (19)	G
Straight braid	J 1/2 (13)	J 1/2 (13)	J 1/2 (13)	J 1/2 (13)	J 1/2 (13)	C
Right angle braid	— —	N 3/4 (19)	N 3/4 (19)	N 3/4 (19)	R 7/8 (22)	Y
Right angle braid with PTFE seal and leads	— —	1E 1 1/4 (32)	1E 1 1/4 (32)	1E 1 1/4 (32)	1E 1 1/4 (32)	A
Straight braid with PTFE seal and leads	— —	N 3/4 (19)	N 3/4 (19)	N 3/4 (19)	N 3/4 (19)	F
Right angle hose with PTFE seal and leads	— —	1E 1 1/4 (32)	1E 1 1/4 (32)	1E 1 1/4 (32)	1E 1 1/4 (32)	M

LA options are available as shown in the table above. To order any of these options, please build the order number by specifying the Watlow part number, length adder code, option code and lead length.

Lead Type Codes

Type	Maximum Temperature	Option Code
GGS	482°F (250°C)	None
MGT	842°F (450°C)	H
PTFE	392°F (200°C)	T

Note: Available for LA fiberglass leads.

No-Heat Length Adder Codes

No-Heat Option in. (mm)	Length Adder Code
3/4 (19)	N
1 1/4 (32)	1E
1 3/4 (44)	1N
2 1/4 (56)	2E

Cartridge/Insertion Heaters



FIREROD Cartridge Heaters

Non-LA

Modification Coding

Watlow offers heaters in various diameters, lengths and volt-wattage combinations that are ready for shipping. Basic modifications can be made and heaters are shipped the same day. Modifications include flanges, threaded fittings, locating rings, ceramic beads and crimped on leads. Following is a list of all available non-LA mounting and pin option codes.

Mounting Option Codes

- BA - Small flange FS (available on 1/4, 3/8 and 1/2 in.)
- BB - Medium flange FM (available on 1/4, 3/8, 1/2, 5/8 and 3/4 in.)
- BC - Large flange FL (available on 5/8 and 3/4 in.)
- BD - Locating ring (available on 1/4, 3/8, 1/2, 5/8 and 3/4 in.)
- BG - Single stainless steel fitting
- BH - Double stainless steel fitting
- BY - Stainless steel reversed

Pin Option Codes

- AA - Short pins 3/8 in. (10 mm)
- AB - Medium pins 5/8 in. (16 mm)
- AC - Long pins 1 3/4 in. (45 mm)
- AD - Stagger pins
- AE - Ceramic beads 1/2 in. (13 mm)
- AF - Ceramic beads 3/4 in. (19 mm)
- AG - Ceramic beads 1 in. (25 mm)
- AH - Ceramic beads 1 1/4 in. (32 mm)
- AJ - Ceramic beads 1 1/2 in. (38 mm)



Crimped-on Leads



Ceramic Beads



Locating Ring



Threaded Fitting

Cartridge/Insertion Heaters



FIREROD Cartridge Heaters

Made-to-Order

Straight Options

Swaged-in Flexible Leads

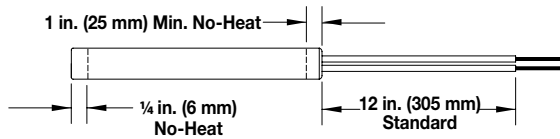

Swaged-in flexible leads are used in applications where a high degree of flexing exists or leads must be bent sharply adjacent to the heater without exposing or breaking the conductor. Stranded wire leads are connected internally and exit through the lead end.

Lead wire type is high temperature fiberglass. The maximum temperature of the standard fiberglass end piece is 842°F (450°C). Unless specified, 12 in. (305 mm) leads are supplied.

The minimum lead end for no-heat is 1 in. (25 mm) min. or 12 percent of overall heater length. Additional no-heat may be required to keep the end piece and leads below the maximum operating temperatures.

PTFE Seal and Leads

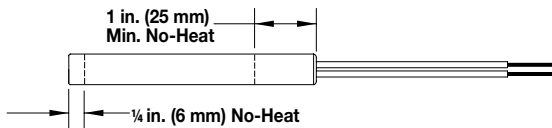

A PTFE seal and leads protect the heater against moisture and contamination from cleaning solvents, plastic material, fumes and organic tapes. This seal is effective up to 392°F (200°C) under continuous operation.

The PTFE seal and leads have a minimum lead end unheated section of 1 in. (25 mm). Additional no-heat may be required to keep the seal below its maximum operating temperature.

Straight Stainless Steel Hose

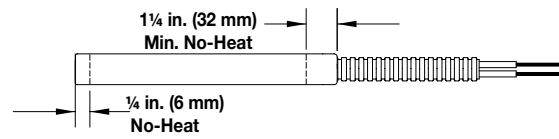

A straight stainless steel hose provides the best protection against abrasion from sharp edges. It also offers ease of handling and wiring in abrasive environments.

Unless specified, a 12 in. (305 mm) hose is supplied. Leads are 2 in. (51 mm) longer than the hose.

Note: This option is available with PTFE leads and seal. Minimum no-heats are longer. Contact your Watlow representative for details.

Straight Stainless Steel Braid

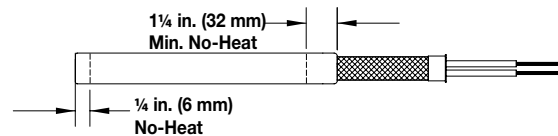

A straight stainless braid is designed to protect leads from abrasion against sharp edges and is Watlow's most flexible protective lead arrangement.

Unless specified, a 12 in. (305 mm) braid is supplied. Leads are 2 in. (51 mm) longer than the braid.

Note: This option is available with PTFE leads and seal. Minimum no-heats are longer. Contact your Watlow representative for details.

Note: If your application requires smaller no heat, contact your Watlow representative for details.

Cartridge/Insertion Heaters



FIREROD Cartridge Heaters

Made-to-Order

Right Angle Options

Right Angle Leads

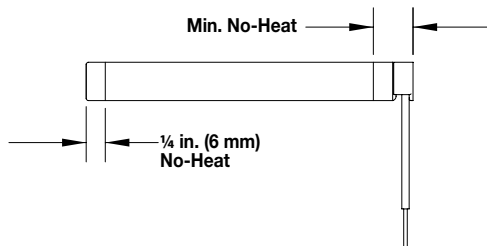

Right angle leads are used in applications with a high degree of flexing and when space limitations are critical. Standard lead wires are connected internally (swaged-in) and exit at a 90° angle at the end of the heater.

Diameter	1/4	3/8	1/2	5/8	3/4
Min. no-heat in. (mm)	1 1/4 (32)	1 1/4 (32)	1 5/16 (33)	1 7/16 (37)	1 7/16 (37)

Note: This option is available with PTFE leads and seal. Minimum no-heats are longer. Contact your Watlow representative for details.

Right Angle Stainless Steel Hose

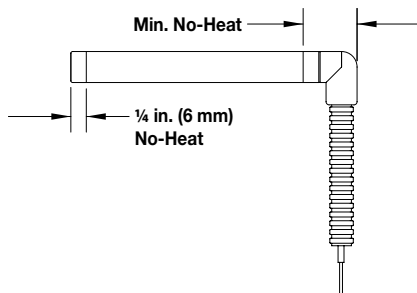

The diameter of the right angle extension is equal to the nominal diameter of the heater.

A right angle stainless steel hose is provided for wiring convenience. It protects leads from abrasion against sharp edges.

Unless specified, a 12 in. (305 mm) hose is supplied. Leads are 2 in. (51 mm) longer than the hose.

Diameter	1/4	3/8	1/2	5/8	3/4
Min. no-heat in. (mm)	1 5/16 (33)	1 3/8 (35)	1 9/16 (40)	1 11/16 (43)	1 13/16 (46)

Note: This option is available with PTFE leads and seal. Minimum no-heats are longer. Contact your Watlow representative for details.

Right Angle Stainless Steel Braid

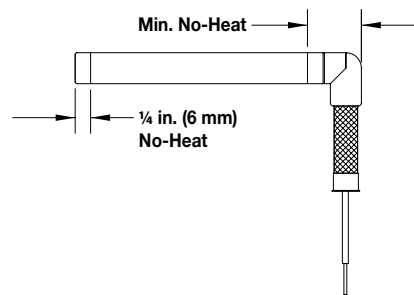

The diameter of the right angle extension is equal to the nominal diameter of the heater.

A right angle stainless steel braid is provided for wiring convenience. It protects leads from abrasion against sharp edges.

Unless specified, a 12 in. (305 mm) braid is supplied. Leads are 2 in. (51 mm) longer than the braid.

Diameter	1/4	3/8	1/2	5/8	3/4
Min. no-heat in. (mm)	1 5/16 (33)	1 3/8 (35)	1 9/16 (40)	1 11/16 (43)	1 13/16 (46)

Note: This option is available with PTFE leads and seal. Minimum no-heats are longer. Contact your Watlow representative for details.

Cartridge/Insertion Heaters



FIREROD Cartridge Heaters

Made-to-Order

Termination Options

Ground Lead

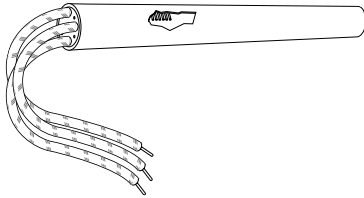

Ground leads are a safety feature to protect both workers and equipment. This configuration is not available on all options. Contact your Watlow representative for additional information. To order, specify **ground lead**.

Ceramic Bead Insulation

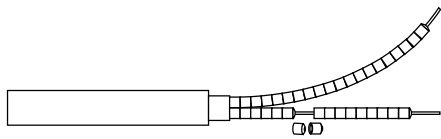

Ceramic bead insulation protects the leads from high ambient temperatures above 842°F (450°C). The beads fit over solid conductors that extend to reach a cooler area where flexible wires can be attached. This option is not available on 1/8 in. (3 mm) diameter leads. The maximum available length on FIRERODs is 6 in. (152 mm). To order, specify **ceramic beads** and length, and additional lead length.

Options

Distributed Wattage

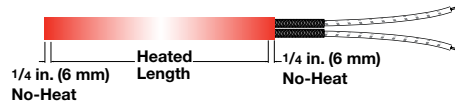

Distributed wattage varies the watt density along the length of the heater. This construction technique compensates for heat losses along the edges of heated parts and is ideal for seal bar applications.

To order, specify **distributed wattage** and give the length and wattage for each section.

Thermocouple Types

ASTM Code	Conductor Characteristics		Temperature Range °F (°C)
	Positive	Negative	
J	Iron (Magnetic) (White)	Constantan (Non-Magnetic) (Red)	0 to 1400 (-20 to 760)
K	Chromel® (Non Magnetic) (Yellow)	Alumel® (Magnetic) (Red)	0 to 2300 (-20 to 1260)

For other ISA types, contact your Watlow representative.

Style A

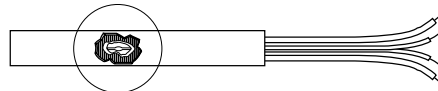

Style B

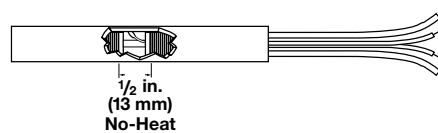

Style C

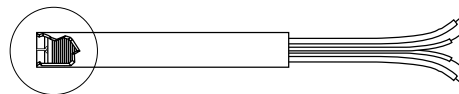

Cartridge/Insertion Heaters



FIREROD Cartridge Heaters

Made-to-Order

Options

Internal Thermocouple

Style A internal thermocouples can be used to evaluate heat transfer efficiency of an application. This measurement can help to cut energy costs and increase heater life. The ungrounded junction is located in the heater core to monitor the internal temperature of the heater.

The Style B internal thermocouple provides a good approximation of part temperature and is located anywhere along the length of the heater. Due to variations in production, this style may be grounded or ungrounded.

This junction is located adjacent to the inside heater sheath in the center of the heated section unless otherwise specified. A 1/2 in. (13 mm) unheated section is required.

A Style C internal thermocouple is useful in applications where material flows past the end of the heater, as in plastic molding. This grounded junction is embedded in a special end disc. Unless requested, the disc end is not mechanically sealed.

To order, specify **internal thermocouple, Style A, B or C** and **thermocouple ASTM Type J or K**.

If not specified, 12 in. (305 mm) thermocouple leads are supplied.

Availability

All styles are available on all diameters with the exception of 1/8 in. (3.2 mm) diameter, which is available only with Style C, and 1 in. (25 mm) which is available only with Style A and B.

Mounting Options

Threaded Fittings

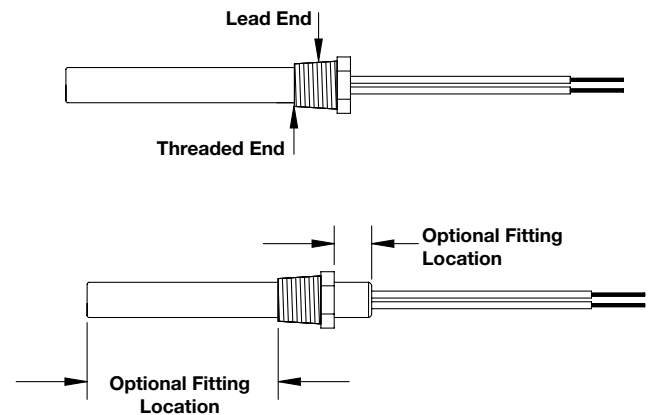

Threaded fittings allow fast, water-tight heater installation into a threaded hole. Standard fittings are 304 stainless steel and welded to the heater sheath. Other materials, including brass are available as an extended option. Double threaded fittings are also available.

Unless specified, the fitting hex is located flush with the lead end.

Threaded Fittings Specifications

Heater Diameter in.	Pipe Thread Size (NPTF) in. (mm)	Single Thread Fitting Length in. (mm)	Double Thread Fitting Length in. (mm)
1/4	1/8 (3)	1/2 (13)	7/8 (22)
3/8	1/4 (6)	5/8 (16)	1 ⁵ / ₁₆ (33)
1/2	3/8 (10)	3/4 (19)	1 ³ / ₈ (35)
5/8	1/2 (13)	7/8 (22)	1 ¹³ / ₁₆ (46)
3/4	3/4 (19)	1 (25)	1 ¹³ / ₁₆ (46)
1	1 (25)	1 (25)	1 ¹ / ₂ (38)

Cartridge/Insertion Heaters



FIREROD Cartridge Heaters

Made-to-Order

Mounting Options (Continued)

Flanges

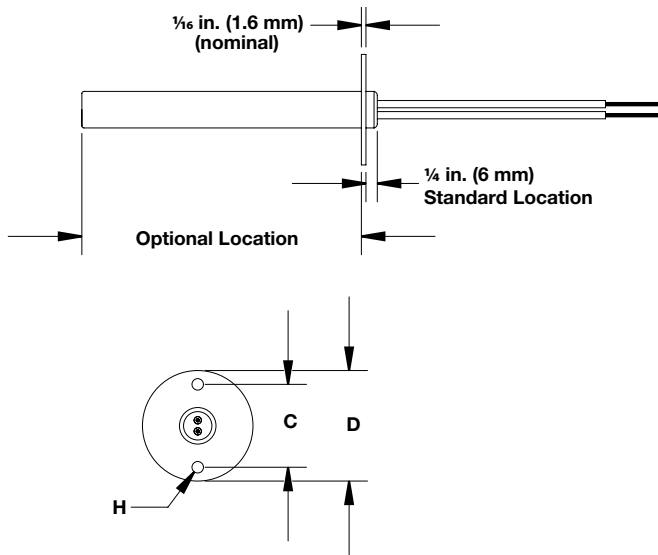

Stainless steel flanges are a convenient mounting method and can be used to position a heater within an application. The standard location is 1/4 in. (6 mm) from the lead end. However, a specific location may be requested in any location along the no-heat section. Unless specified, flanges are staked to the sheath.

To order, specify **flange size** and location.

Flange Specifications

FIREROD Diameter in.	Flange Size	D in. (mm)	C in. (mm)	H in.
1/8, 1/4, 3/8, 1/2	FS	1 (25)	3/4 (19)	0.144
1/4, 3/8, 1/2, 5/8, 3/4	FM	1 1/2 (38)	1 1/8 (28)	0.156
5/8, 3/4, 1	FL	2 (51)	1 1/2 (38)	0.201

Locating Rings

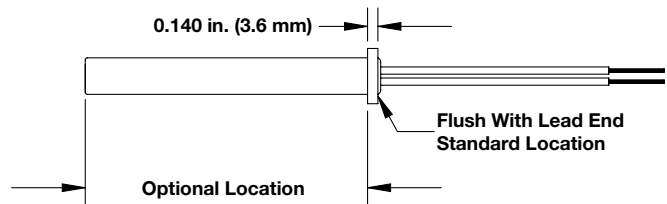

A stainless steel locating ring can be used as a retaining collar to position a FIREROD heater if mounting requirements are not critical. Standard locating rings are staked to the heater sheath.

To order, specify **locating ring** and location.

Locating Ring Specifications

Diameter	1/4	3/8	1/2	5/8	3/4
Ring O.D. in. (mm)	1/2 (13)	5/8 (16)	3/4 (19)	7/8 (22)	1 (25)

Cartridge/Insertion Heaters

**EXTENDED
CAPABILITY**



Extended Capabilities for Custom Cartridge Heaters

Special cartridge heaters can be engineered and designed to meet the most difficult applications and the highest quality standards. From nuclear power plants to open heart surgeries, Watlow cartridge heaters with extended capabilities are exceeding customer expectations. For more than 90 years, emphasis on sound engineering and quality control has established Watlow as a preferred supplier for many high-performance heating requirements. For large opportunities, a solution for you can be engineered to accommodate:

- Custom diameters
- High watt density applications
- Long heater lengths
- Low current leakage constructions
- Special testing and inspection
- Non-destructive testing: x-ray, helium leak tests and start up verification
- Integrated thermostats
- Value added integration of the Watlow heater into a sub-assembly
- Complete documentation packages: approval drawings, material traceability, inspection traceability and other compliance documents

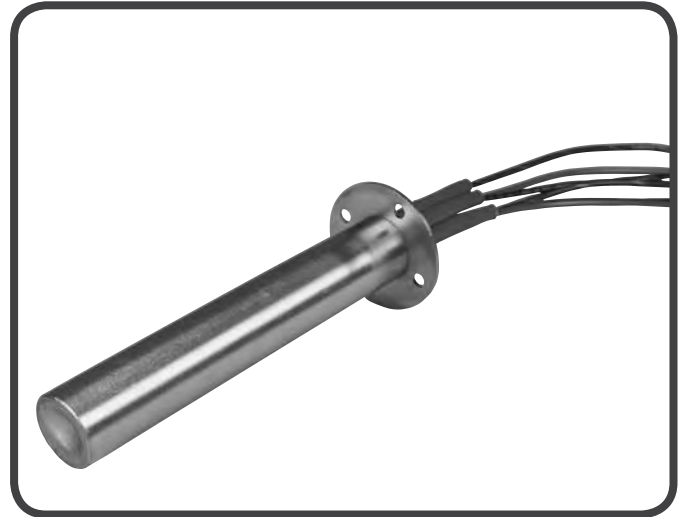

High Performance Cartridge Heaters

Watlow has developed a wide range of heaters and assemblies to meet requirements for the most demanding applications. Watlow can engineer and manufacture heaters with low leakage constructions, integrated temperature controls or limits and unique customer hardware and connectors.

Cartridge/Insertion Heaters

**EXTENDED
CAPABILITY**



Extended Capabilities for Custom Cartridge Heaters

Mineral Insulated (MI Leads)

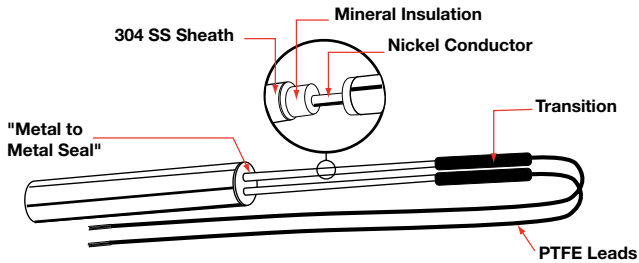

MI leads handle both high temperatures and contamination, and resist other problems including abrasion and excessive vibration. The metal seal and swaged-in formable MI cable leads can handle temperatures up to 1500°F (815°C). The lead end seal resists moisture and other forms of contamination, including gases, oils, plastic drool, solvents and water.

Note: MI leads do not provide a hermetic seal on the heater.

Benefits

- Increases heater life
- Minimizes down time
- Resists moisture contamination
- Allows a cartridge heater to be used where it was not previously possible
- Resists abrasion and vibration
- Forms and bends to fit the contours of wiring raceways
- Protects against high temperatures without additional insulation

Typical Applications

- Plastic molding
- Medical device manufacturing
- Food handling equipment
- Zinc die-casting

Technical Data

Max. temp. of cable: 1500°F (815°C)

Max. temp. of cable to lead transition: 300°F (149°C)
(where flexible leads attach to cable)

Cable sheath material: 304 SS

Conductor material: nickel

Max. voltage: 240V

Transition length: 1¹/₈ in. (28.6 mm)

Lead Types

PTFE 392°F (200°C) – T

Heater Diameter in.	Max. Current Amperes	Conductor Diameter in.	Cable Diameter in.	Transition Diameter in.	Cable Length Min. in.	Max. in.	Min. Bend Radius	Max. Voltage in.	Length Adder
3/8	7.0	0.044	0.108	0.230	6	72	0.225	240	G (3/8)
1/2	7.0	0.044	0.108	0.230	6	72	0.225	240	K (9/16)
5/8	9.7	0.062	0.138	0.250	6	72	0.280	240	L (5/8)
3/4	9.7	0.062	0.138	0.250	6	72	0.280	240	L (5/8)

This information pertains to standard FIREROD heaters.

Note: Extended capabilities are subject to a business case review.

Cartridge/Insertion Heaters

**EXTENDED
CAPABILITY**



Extended Capabilities for Custom Cartridge Heaters

Termination Options

Low Electrical Leakage

This construction technique minimizes current leakage of the heating element. It is especially useful in critical medical applications where low set point ground fault interrupts are used.

Low electrical leakage is available on $\frac{3}{8}$, $\frac{1}{2}$, $\frac{5}{8}$ and $\frac{3}{4}$ in. (10, 13, 16 and 19 mm) diameter FIREROD heaters.

To order, specify **low electrical leakage**.

Silicone Rubber Seal and Leads

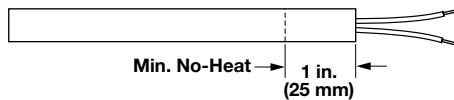

Made-to-order silicone rubber seal and leads protect the heater against moisture and contamination from lubricating oil, cleaning solvents, plastic material, fumes and organic tapes. This seal is effective up to 302°F (150°C) under continuous operation.

Silicone rubber seal and leads for made-to-order units greater than 10 in. (250 mm) long comprise a minimum no-heat section of approximately 12 percent of the overall length. Longer no-heat sections are available if required.

Post Terminals

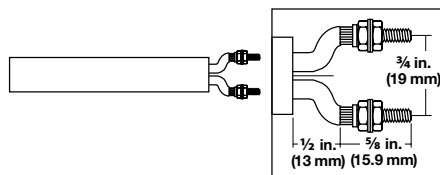

Post terminals provide a quick, secure connection with ring or fork connectors or bus bars. Threaded 6-32 studs are soldered to the solid power pins. Nuts and washers are provided.

Post terminals are available on FIREROD heaters of $\frac{5}{8}$, $\frac{3}{4}$ and 1 in. (16, 19 and 25 mm) diameter. On 1 in. (25 mm) diameters, pins are straight. To order, specify **post terminals**.

Epoxy Seal

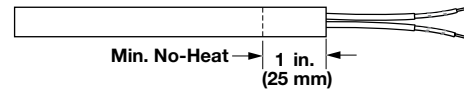

Epoxy seals help protect the heater against moisture and contamination from lubricating oil, cleaning solvents, plastic material, fumes and organic tapes. These seals are effective up to 250°F (121°C) under continuous operation.

Epoxy seals can be ordered only on units greater than $\frac{1}{8}$ in. (3 mm) in diameter with crimped on leads. The minimum no-heat section at the lead end is 1 in. (25 mm). Longer no-heat sections are available upon request.

To order, specify **epoxy seal**.

Options

Individually Controlled Heat Zones

Individually controlled heat zones offer the flexibility to control temperature by zones, along the length of the FIREROD heater. This is an advantage for heating requirements of certain applications, such as seal bars. This internal construction can be ordered on $\frac{5}{8}$, $\frac{3}{4}$ and 1 in. (16, 19 and 25 mm) diameter FIREROD heaters. To order, specify **individually controlled heat zones** and wattage and length per zone.

Passivation

During the manufacturing and handling of stainless steel, particles of iron or tool steel may embed in the sheath. If they are not removed, particles may corrode and produce rust spots. In critical sheath contact applications for the medical industry, passivation will remove free iron from the sheath. To order, specify **316L stainless steel sheath** and **passivation**.

Note: Extended capabilities are subject to a business case review.

Cartridge/Insertion Heaters

**EXTENDED
CAPABILITY**



Extended Capabilities for Custom Cartridge Heaters

Options (Continued)

Bent FIREROD

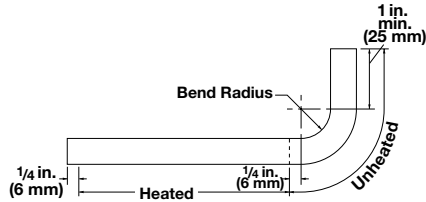

In applications where leads must exit at an angle, a bend can be made in the unheated section only. Heated sections may be on either side of the bend. It is recommended that the heater be bent at the Watlow factory.

A 304 stainless steel sheath is used on bent FIREROD heaters. If the sheath temperature exceeds 1000°F (540°C), contact your Watlow representative.

See dimensions noted on the chart or contact your Watlow representative if application needs exceed limitations shown.

FIREROD Diameter in.	Min. Required No-Heat Length in. (mm)	Bend Radius in. (mm)
1/4	2 1/4 (56)	1/2 (13)
3/8	2 3/8 (60)	1/2 (13)
1/2	2 7/8 (72)	3/4 (19)
5/8	3 5/16 (83)	1 (25)
1/2	3 13/16 (98)	1 1/4 (32)

Centerless Grinding

Centerless grinding can be used to furnish precision diameters to permit closer heater-to-part fit allowing higher watt densities to be used.

For centerless ground heaters, the heater must have PTFE seal and leads (maximum 12 in. (305 mm) lead length) or crimped on leads. Longer lead lengths are available, but require an external connection. The length of a FIREROD available for centerless grinding depends on the construction. Please contact your Watlow representative for assistance. To order, specify **centerless grinding**.

FIREROD Diameter in.	Actual Precision Diameter in.
1/4	0.241 ± 0.0005
3/8	0.363 ± 0.0005
1/2	0.488 ± 0.0005
5/8	0.613 ± 0.0005
3/4	0.738 ± 0.0005
1	0.984 ± 0.0005

Note: Extended capabilities are subject to a business case review.

Cartridge/Insertion Heaters

**EXTENDED
CAPABILITY**



Extended Capabilities for High-Temperature (HT) FIREROD Heaters

The Watlow HT FIREROD heater is especially designed for high temperature platen applications up to 1600°F (871°C). The HT FIREROD heater utilizes the same industry leading design principles used on all Watlow FIREROD products. Advancing the FIREROD heater enables it to withstand application temperatures up to 400°F (204°C) higher than standard cartridge heaters. HT FIREROD design features, which are important in high temperature applications, include:

- A specially constructed end seal that is virtually airtight to reduce the effects of resistance wire oxidation
- A high-temperature sheath that is treated to improve its emissivity for better heat transfer

Performance Capabilities

- Platen temperatures up to 1600°F (871°C)
- Maximum watt density up to 100 W/in² (15.5 W/cm²)
- Maximum voltage up to 277VAC ground
- Length tolerance of +0, -4 percent standard diameters; +0, -8 percent for special diameter

Made-to-Order Availability

Nominal Diameter in.	Actual Diameter in.	Max. Amperes
1/2	0.496 ± 0.004	10
5/8	0.580 ± 0.004 0.621 ± 0.004	23
3/4	0.710 ± 0.004 0.746 ± 0.004	46
1	0.960 ± 0.006 0.996 ± 0.006	46

Contact your Watlow representative for special diameter requests.

Features and Benefits

High-temperature seal

- Reduces exposure to the atmosphere, which minimizes oxidation of the winding wires resulting in longer element life

Note: The first 2 in. (51 mm) must be outside of the platen in free air and less than 1000°F (538°C).

Alloy 800 sheath

- Transfers heat more efficiently

High emissivity sheath

- Provides better heat transfer and longer life

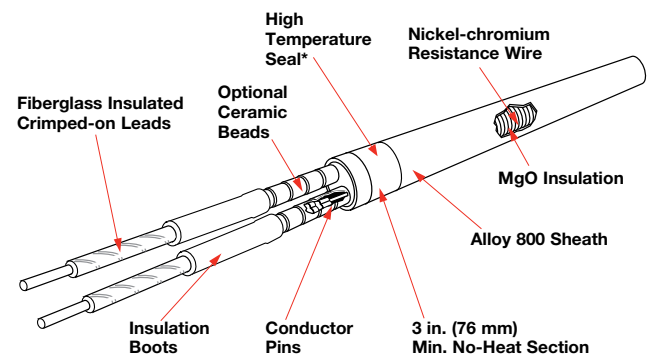

* First 2 in. (51 mm) at lead end must be kept below 1000°F (538°C).

Typical Applications

- Thermo plastic
- Super plastic forming of titanium aircraft parts
- Diffusion bonding to laminate and shape titanium
- High temperature glass forming

Note: Extended capabilities are subject to a business case review.

Cartridge/Insertion Heaters

**EXTENDED
CAPABILITY**



Extended Capabilities for High-Temperature (HT) FIREROD® Heaters

Options

- Thermocouples
- Independently controllable heat zones
- Distributed wattage
- Flanges
- Post terminals
- Bent FIREROD

To consider the HT FIREROD for your application, use the recommended *Maximum Watt Density graph* shown.

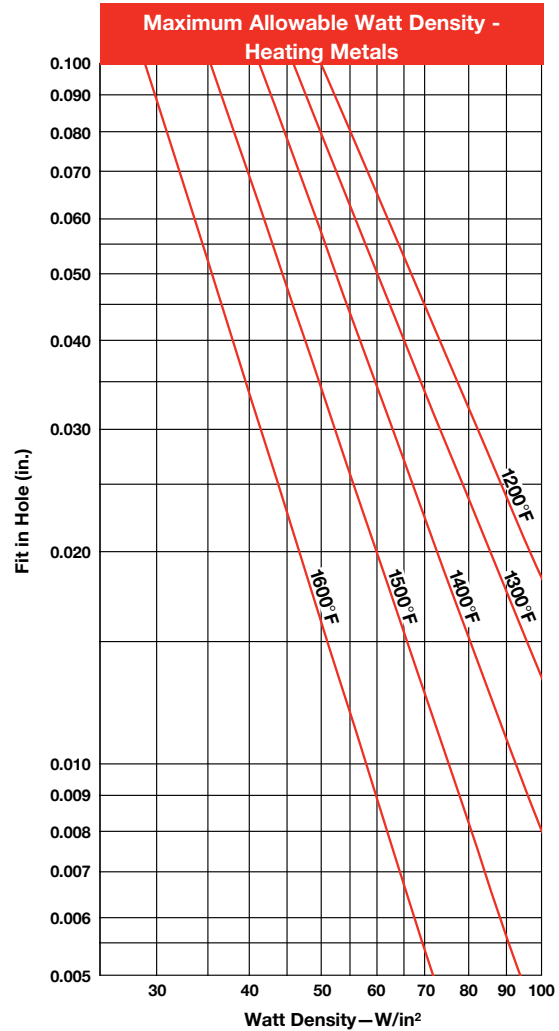

Note: Extended capabilities are subject to a business case review.



FIREROD Cartridge Heaters

The following tables contain lists of standard base FIREROD constructions. The Watlow SELECT™ program offers millions of potential FIREROD configurations to meet your thermal needs, many of those configurations available in one or five days. Please contact your local Watlow distributor or sales office to configure your FIREROD.

Heater Part Numbers

Diameter in.	Sheath Length		Volts	Watts	Watt Density		Approx. Net Wt.		Part Number
	in.	(mm)			W/in ²	(W/cm ²)	lbs	(kg)	
1/8	1	(25.0)	24	20	104	(16)	0.02	(0.009)	C1A-9600^①
	1	(25.0)	24	25	130	(20)	0.02	(0.009)	C1A-9601^①
	1	(25.0)	24	30	157	(24)	0.02	(0.009)	C1A-9602^①
	1	(25.0)	48	20	104	(16)	0.02	(0.009)	C1A-9603^①
	1	(25.0)	48	40	208	(32)	0.02	(0.009)	C1A-9604^①
	1	(25.0)	50	50	260	(40)	0.02	(0.009)	C1A-9605^①
	1 1/4	(32.0)	120	25	87	(13)	0.02	(0.009)	C1E14-L12
	1 1/4	(32.0)	120	50	174	(18)	0.02	(0.009)	C1E13-L12
	1 1/4	(32.0)	240	35	113	(27)	0.02	(0.009)	C1E42-L12
	1 1/2	(38.0)	120	30	78	(12)	0.02	(0.009)	C1J5-L12
	1 1/2	(38.0)	120	60	156	(24)	0.02	(0.009)	C1J6-L12
	2	(51.0)	120	50	87	(13)	0.02	(0.009)	C2A4-L12
	2	(51.0)	120	100	174	(27)	0.02	(0.009)	C2A5-L12
	1/4	1	(25.0)	120	80	208	(32)	0.02	(0.009)
1		(25.0)	120	100	260	(40)	0.02	(0.009)	E1A52-L12
1		(25.0)	120	150	390	(60)	0.02	(0.009)	E1A53-L12
1		(25.0)	240	100	250	(39)	0.02	(0.009)	E1A66-L12
1 1/4		(32.0)	120	75	130	(20)	0.02	(0.009)	E1E41-L12
1 1/4		(32.0)	120	100	173	(27)	0.02	(0.009)	E1E42-L12
1 1/4		(32.0)	120	150	260	(40)	0.02	(0.009)	E1E43-L12
1 1/4		(32.0)	240	225	390	(60)	0.02	(0.009)	E1E61-L12
1 1/2		(38.0)	120	50	65	(10)	0.02	(0.009)	E1J39-L12
1 1/2		(38.0)	120	100	130	(20)	0.02	(0.009)	E1J40-L12
1 1/2		(38.0)	120	150	195	(30)	0.02	(0.009)	E1J41-L12
1 1/2		(38.0)	240	175	228	(35)	0.02	(0.009)	E1J49-L12
1 1/2		(38.0)	120	200	260	(40)	0.02	(0.009)	E1J42-L12
1 1/2		(38.0)	240	200	260	(40)	0.02	(0.009)	E1J52-L12
1 1/2		(38.0)	240	250	325	(50)	0.02	(0.009)	E1J35-L12
2		(51.0)	120	80	68	(11)	0.03	(0.014)	E2A136-L12
2		(51.0)	120	100	87	(13)	0.03	(0.014)	E2A55-L12
2		(51.0)	240	125	108	(17)	0.03	(0.014)	E2A82-L12
2		(51.0)	120	150	130	(20)	0.03	(0.014)	E2A56-L12
2		(51.0)	240	150	130	(20)	0.03	(0.014)	E2A77-L12
2		(51.0)	120	200	173	(27)	0.03	(0.014)	E2A57-L12
2		(51.0)	240	200	173	(27)	0.03	(0.014)	E2A50-L12
2		(51.0)	120	250	217	(33)	0.03	(0.014)	E2A72-L12
2		(51.0)	240	250	215	(33)	0.03	(0.014)	E2A76-L12
2		(51.0)	240	300	260	(40)	0.03	(0.014)	E2A83-L12
2 1/2		(64.0)	120	250	159	(25)	0.03	(0.014)	E2J80-L12
2 1/2		(64.0)	240	250	159	(25)	0.03	(0.014)	E2J49-L12
3		(76.0)	120	100	52	(8)	0.04	(0.018)	E3A48-L12
3		(76.0)	120	200	104	(16)	0.04	(0.018)	E3A49-L12
3		(76.0)	240	200	104	(16)	0.04	(0.018)	E3A60-L12
3		(76.0)	240	250	128	(20)	0.04	(0.018)	E3A124-L12
3		(76.0)	120	300	156	(24)	0.04	(0.018)	E3A50-L12
3		(76.0)	240	300	156	(24)	0.04	(0.018)	E3A51-L12
4		(102.0)	120	100	37	(6)	0.04	(0.018)	E4A28-L12
4	(102.0)	120	200	74	(11)	0.04	(0.018)	E4A29-L12	
4	(102.0)	240	200	74	(11)	0.04	(0.018)	E4A32-L12	
4	(102.0)	120	300	111	(17)	0.04	(0.018)	E4A30-L12	
4	(102.0)	240	300	111	(17)	0.04	(0.018)	E4A6-L12	

CONTINUED

Heaters are manufactured to standard specifications. 12 inch crimped on GGS leads supplied. For other lead termination options, please contact your local Watlow representative.

^①12 inch GGS swaged-in leads, no additional options available.



FIREROD Cartridge Heaters

Heater Part Numbers

Diameter in.	Sheath Length in. (mm)	Volts	Watts	Watt Density W/in ² (W/cm ²)	Approx. Net Wt. lbs (kg)	Part Number
1/4	4 1/2 (114.0)	120	200	64 (10)	0.05 (0.023)	E4J30-L12
	5 (127.0)	240	350	101 (16)	0.05 (0.023)	E5A45-L12
	5 (127.0)	120	400	113 (18)	0.05 (0.023)	E5A57-L12
	5 (127.0)	240	400	113 (18)	0.05 (0.023)	E5A34-L12
	6 (152.0)	240	400	94 (14)	0.06 (0.027)	E6A46-L12
3/8	8 (203.0)	240	800	136 (21)	0.08 (0.036)	E8A76-L12
	1 (25.0)	120	55	95 (15)	0.03 (0.014)	G1A71-L12
	1 (25.0)	120	100	172 (26)	0.03 (0.014)	G1A29-L12
	1 (25.0)	120	150	259 (40)	0.03 (0.014)	G1A38-L12
	1 (25.0)	240	200	344 (53)	0.03 (0.014)	G1A83-L12
	1 1/4 (32.0)	120	100	115 (18)	0.03 (0.014)	G1E91-L12
	1 1/4 (32.0)	120	125	144 (22)	0.03 (0.014)	G1E74-L12
	1 1/4 (32.0)	120	150	172 (27)	0.03 (0.014)	G1E92-L12
	1 1/4 (32.0)	240	150	172 (27)	0.03 (0.014)	G1E93-L12
	1 1/4 (32.0)	120	200	230 (35)	0.03 (0.014)	G1E94-L12
	1 1/4 (32.0)	240	200	230 (35)	0.03 (0.014)	G1E95-L12
	1 1/4 (32.0)	120	400	426 (66)	0.03 (0.014)	G1E99-L12
	1 1/2 (38.0)	120	50	43 (7)	0.04 (0.018)	G1J25-L12
	1 1/2 (38.0)	120	75	65 (10)	0.04 (0.018)	G1J70-L12
	1 1/2 (38.0)	120	80	68 (11)	0.04 (0.018)	G1J66-L12
	1 1/2 (38.0)	120	100	86 (13)	0.04 (0.018)	G1J59-L12
	1 1/2 (38.0)	240	100	86 (13)	0.04 (0.018)	G1J110-L12
	1 1/2 (38.0)	240	125	106 (16)	0.04 (0.018)	G1J182-L12
	1 1/2 (38.0)	120	150	129 (20)	0.04 (0.018)	G1J31-L12
	1 1/2 (38.0)	240	150	129 (20)	0.04 (0.018)	G1J39-L12
	1 1/2 (38.0)	120	200	173 (27)	0.04 (0.018)	G1J85-L12
	1 1/2 (38.0)	240	200	173 (27)	0.04 (0.018)	G1J73-L12
	1 1/2 (38.0)	120	250	216 (33)	0.04 (0.018)	G1J86-L12
	1 1/2 (38.0)	240	250	216 (33)	0.04 (0.018)	G1J54-L12
	1 3/4 (45.0)	120	125	86 (13)	0.05 (0.023)	G1N45-L12
	1 3/4 (45.0)	120	175	122 (19)	0.05 (0.023)	G1N46-L12
	1 3/4 (45.0)	120	250	172 (27)	0.05 (0.023)	G1N43-L12
	1 3/4 (45.0)	240	250	172 (27)	0.05 (0.023)	G1N32-L12
	2 (51.0)	120	50	29 (5)	0.06 (0.027)	G2A53-L12
	2 (51.0)	120	75	42 (7)	0.06 (0.027)	G2A192-L12
	2 (51.0)	120	100	57 (9)	0.06 (0.027)	G2A84-L12
	2 (51.0)	240	100	57 (9)	0.06 (0.027)	G2A76-L12
	2 (51.0)	120	150	86 (13)	0.06 (0.027)	G2A56-L12
	2 (51.0)	240	150	86 (13)	0.06 (0.027)	G2A81-L12
	2 (51.0)	120	200	115 (18)	0.06 (0.027)	G2A127-L12
2 (51.0)	240	200	115 (18)	0.06 (0.027)	G2A37-L12	
2 (51.0)	120	250	144 (22)	0.06 (0.027)	G2A47-L12	
2 (51.0)	240	250	144 (22)	0.06 (0.027)	G2A73-L12	
2 (51.0)	120	300	172 (27)	0.06 (0.027)	G2A139-L12	
2 (51.0)	240	300	172 (27)	0.06 (0.027)	G2A98-L12	
2 (51.0)	120	400	230 (36)	0.06 (0.027)	G2A153-L12	
2 (51.0)	240	400	230 (36)	0.06 (0.027)	G2A146-L12	
2 (51.0)	120	500	282 (44)	0.06 (0.027)	G2A95-L12	
2 (51.0)	240	500	282 (44)	0.06 (0.027)	G2A97-L12	
2 1/4 (57.0)	120	75	37 (6)	0.07 (0.032)	G2E88-L12	
2 1/4 (57.0)	120	125	62 (10)	0.07 (0.032)	G2E89-L12	

CONTINUED

Heaters are manufactured to standard specifications. 12 inch crimped on GGS leads supplied. For other lead termination options, please contact your local Watlow representative.

Cartridge/Insertion Heaters



FIREROD Cartridge Heaters

Heater Part Numbers

Diameter in.	Sheath Length		Volts	Watts	Watt Density		Approx. Net Wt.		Part Number
	in.	(mm)			W/in ²	(W/cm ²)	lbs	(kg)	
3/8	2 1/4	(57.0)	240	125	62	(10)	0.07	(0.032)	G2E138-L12
	2 1/4	(57.0)	240	150	73	(11)	0.07	(0.032)	G2E68-L12
	2 1/4	(57.0)	120	175	86	(13)	0.07	(0.032)	G2E90-L12
	2 1/4	(57.0)	120	250	123	(19)	0.07	(0.032)	G2E2-L12
	2 1/4	(57.0)	240	250	123	(19)	0.07	(0.032)	G2E78-L12
	2 1/4	(57.0)	120	300	148	(23)	0.07	(0.032)	G2E108-L12
	2 1/4	(57.0)	240	300	148	(23)	0.07	(0.032)	G2E12-L12
	2 1/4	(57.0)	120	350	173	(27)	0.07	(0.032)	G2E91-L12
	2 1/4	(57.0)	240	350	173	(27)	0.07	(0.032)	G2E75-L12
	2 1/2	(64.0)	120	200	87	(13)	0.07	(0.032)	G2J110-L12
	2 1/2	(64.0)	240	200	87	(13)	0.07	(0.032)	G2J81-L12
	2 1/2	(64.0)	120	250	108	(17)	0.07	(0.032)	G2J46-L12
	2 1/2	(64.0)	240	250	108	(17)	0.07	(0.032)	G2J80-L12
	2 1/2	(64.0)	120	300	130	(20)	0.07	(0.032)	G2J118-L12
	2 1/2	(64.0)	240	300	130	(20)	0.07	(0.032)	G2J119-L12
	2 1/2	(64.0)	120	400	174	(27)	0.07	(0.032)	G2J26-L12
	2 1/2	(64.0)	240	400	174	(27)	0.07	(0.032)	G2J146-L12
	2 1/2	(64.0)	120	500	216	(33)	0.07	(0.032)	G2J109-L12
	2 1/2	(64.0)	240	500	216	(33)	0.07	(0.032)	G2J52-L12
	3	(76.0)	120	100	34	(5)	0.08	(0.036)	G3A55-L12
	3	(76.0)	240	100	34	(5)	0.08	(0.036)	G3A137-L12
	3	(76.0)	120	150	52	(8)	0.08	(0.036)	G3A121-L12
	3	(76.0)	120	200	69	(11)	0.08	(0.036)	G3A61-L12
	3	(76.0)	240	200	69	(11)	0.08	(0.036)	G3A39-L12
	3	(76.0)	120	250	86	(13)	0.08	(0.036)	G3A52-L12
	3	(76.0)	240	250	86	(13)	0.08	(0.036)	G3A54-L12
	3	(76.0)	120	300	104	(16)	0.08	(0.036)	G3A73-L12
	3	(76.0)	240	300	104	(16)	0.08	(0.036)	G3A92-L12
	3	(76.0)	120	400	138	(21)	0.08	(0.036)	G3A44-L12
	3	(76.0)	240	400	138	(21)	0.08	(0.036)	G3A65-L12
	3	(76.0)	120	500	173	(27)	0.08	(0.036)	G3A119-L12
	3	(76.0)	240	500	173	(27)	0.08	(0.036)	G3A120-L12
	3	(76.0)	240	600	208	(32)	0.08	(0.036)	G3A133-L12
3 1/2	(89.0)	120	250	72	(11)	0.09	(0.041)	G3J77-L12	
3 1/2	(89.0)	240	250	72	(11)	0.09	(0.041)	G3J65-L12	
3 1/2	(89.0)	120	300	87	(13)	0.09	(0.041)	G3J87-L12	
3 1/2	(89.0)	240	300	87	(13)	0.09	(0.041)	G3J68-L12	
3 1/2	(89.0)	120	500	144	(22)	0.09	(0.041)	G3J22-L12	
3 1/2	(89.0)	240	500	144	(22)	0.09	(0.041)	G3J63-L12	
4	(102.0)	120	125	31	(5)	0.09	(0.041)	G4A54-L12	
4	(102.0)	240	125	31	(5)	0.09	(0.041)	G4A163-L12	
4	(102.0)	120	150	37	(6)	0.09	(0.041)	G4A78-L12	
4	(102.0)	120	175	43	(7)	0.09	(0.041)	G4A191-L12	
4	(102.0)	120	250	62	(10)	0.09	(0.041)	G4A40-L12	
4	(102.0)	240	250	62	(10)	0.09	(0.041)	G4A87-L12	
4	(102.0)	120	300	74	(11)	0.09	(0.041)	G4A94-L12	
4	(102.0)	240	300	74	(11)	0.09	(0.041)	G4A95-L12	
4	(102.0)	120	400	99	(15)	0.09	(0.041)	G4A48-L12	
4	(102.0)	240	400	99	(15)	0.09	(0.041)	G4A44-L12	
4	(102.0)	240	450	109	(17)	0.09	(0.041)	G4A64-L12	
4	(102.0)	120	500	123	(19)	0.09	(0.041)	G4A96-L12	
4	(102.0)	240	500	123	(19)	0.09	(0.041)	G4A92-L12	

CONTINUED

Heaters are manufactured to standard specifications. 12 inch crimped on GGS leads supplied. For other lead termination options, please contact your local Watlow representative.

Cartridge/Insertion Heaters



FIREROD Cartridge Heaters

Heater Part Numbers

Diameter in.	Sheath Length		Volts	Watts	Watt Density		Approx. Net Wt.		Part Number
	in.	(mm)			W/in ²	(W/cm ²)	lbs	(kg)	
3/8	4	(102.0)	120	550	134	(21)	0.09	(0.041)	G4A200-L12
	4 1/4	(108.0)	240	300	67	(10)	0.09	(0.041)	G4E25-L12
	4 1/4	(108.0)	240	750	167	(26)	0.09	(0.041)	G4E15-L12
	4 1/2	(114.0)	120	300	65	(10)	0.10	(0.045)	G4J54-L12
	4 1/2	(114.0)	240	300	65	(10)	0.10	(0.045)	G4J33-L12
	4 1/2	(114.0)	120	500	108	(17)	0.10	(0.045)	G4J55-L12
	4 1/2	(114.0)	240	500	108	(17)	0.10	(0.045)	G4J37-L12
	5	(127.0)	120	150	29	(4)	0.11	(0.050)	G5A68-L12
	5	(127.0)	240	150	29	(4)	0.11	(0.050)	G5A56-L12
	5	(127.0)	120	300	58	(9)	0.11	(0.050)	G5A69-L12
	5	(127.0)	240	300	58	(9)	0.11	(0.050)	G5A70-L12
	5	(127.0)	120	500	96	(15)	0.11	(0.050)	G5A38-L12
	5	(127.0)	240	500	96	(15)	0.11	(0.050)	G5A71-L12
	5	(127.0)	240	750	144	(22)	0.11	(0.050)	G5A67-L12
	5	(127.0)	240	1000	192	(30)	0.11	(0.050)	G5A115-L12
	5 1/4	(133.0)	240	200	45	(7)	0.12	(0.054)	G5E16-L12
	5 1/2	(140.0)	240	600	104	(16)	0.12	(0.054)	G5J36-L12
	5 1/2	(140.0)	240	1000	173	(27)	0.12	(0.054)	G5J45-L12
	6	(152.0)	120	200	31	(5)	0.13	(0.059)	G6A80-L12
	6	(152.0)	120	250	39	(6)	0.13	(0.059)	G6A40-L12
	6	(152.0)	240	250	39	(6)	0.13	(0.059)	G6A92-L12
	6	(152.0)	120	400	63	(10)	0.13	(0.059)	G6A81-L12
	6	(152.0)	240	400	63	(10)	0.13	(0.059)	G6A82-L12
	6	(152.0)	120	500	79	(12)	0.13	(0.059)	G6A125-L12
	6	(152.0)	240	500	79	(12)	0.13	(0.059)	G6A59-L12
	6	(152.0)	120	600	94	(15)	0.13	(0.059)	G6A56-L12
	6	(152.0)	240	600	94	(15)	0.13	(0.059)	G6A51-L12
	6	(152.0)	240	750	117	(18)	0.13	(0.059)	G6A46-L12
	6	(152.0)	240	1000	157	(24)	0.13	(0.059)	G6A83-L12
	6 1/2	(165.0)	240	600	86	(13)	0.14	(0.064)	G6J23-L12
	6 1/2	(165.0)	240	1000	144	(22)	0.14	(0.064)	G6J33-L12
	7	(178.0)	120	250	33	(5)	0.14	(0.064)	G7A40-L12
	7	(178.0)	240	250	33	(5)	0.14	(0.064)	G7A32-L12
	7	(178.0)	240	500	65	(10)	0.14	(0.064)	G7A30-L12
	7	(178.0)	120	600	80	(12)	0.14	(0.064)	G7A41-L12
	7	(178.0)	240	600	80	(12)	0.14	(0.064)	G7A42-L12
7	(178.0)	240	1000	133	(21)	0.14	(0.064)	G7A43-L12	
7 1/2	(191.0)	240	600	74	(11)	0.15	(0.068)	G7J27-L12	
7 1/2	(191.0)	240	1000	124	(19)	0.15	(0.068)	G7J28-L12	
8	(203.0)	120	300	34	(5)	0.16	(0.073)	G8A54-L12	
8	(203.0)	240	300	34	(5)	0.16	(0.073)	G8A47-L12	
8	(203.0)	120	400	45	(7)	0.16	(0.073)	G8A109-L12	
8	(203.0)	120	500	58	(9)	0.16	(0.073)	G8A81-L12	
8	(203.0)	240	500	58	(9)	0.16	(0.073)	G8A32-L12	
8	(203.0)	120	600	69	(11)	0.16	(0.073)	G8A53-L12	
8	(203.0)	240	600	69	(11)	0.16	(0.073)	G8A37-L12	
8	(203.0)	240	700	79	(12)	0.16	(0.073)	G8A98-L12	
8	(203.0)	240	1000	115	(18)	0.16	(0.073)	G8A45-L12	
9	(229.0)	240	1000	100	(16)	0.18	(0.082)	G9A37-L12	
9 1/2	(241.0)	240	600	57	(9)	0.19	(0.086)	G9J20-L12	
9 1/2	(241.0)	240	1000	96	(15)	0.19	(0.086)	G9J12-L12	
10	(254.0)	120	400	36	(6)	0.19	(0.086)	G10A48-L12	

CONTINUED

Heaters are manufactured to standard specifications. 12 inch crimped on GGS leads supplied. For other lead termination options, please contact your local Watlow representative.

Cartridge/Insertion Heaters



FIREROD Cartridge Heaters

Heater Part Numbers

Diameter in.	Sheath Length		Volts	Watts	Watt Density		Approx. Net Wt.		Part Number
	in.	(mm)			W/in ²	(W/cm ²)	lbs	(kg)	
3/8	10	(254.0)	120	600	54	(8)	0.19	(0.086)	G10A35-L12
	10	(254.0)	240	600	54	(8)	0.19	(0.086)	G10A31-L12
	10	(254.0)	240	1000	91	(14)	0.19	(0.086)	G10A32-L12
	12	(305.0)	120	400	30	(5)	0.22	(0.100)	G12A45-L12
	12	(305.0)	120	600	45	(7)	0.22	(0.100)	G12A29-L12
	12	(305.0)	240	600	45	(7)	0.22	(0.100)	G12A46-L12
1/2	12	(305.0)	240	1000	75	(12)	0.22	(0.100)	G12A47-L12
	1	(25.0)	120	50	65	(10)	0.06	(0.027)	J1A30-L12
	1	(25.0)	120	150	193	(30)	0.06	(0.027)	J1A31-L12
	1 1/4	(32.0)	120	50	43	(7)	0.07	(0.032)	J1E50-L12
	1 1/4	(32.0)	120	125	107	(17)	0.07	(0.032)	J1E51-L12
	1 1/4	(32.0)	240	125	107	(17)	0.07	(0.032)	J1E58-L12
	1 1/4	(32.0)	240	200	172	(27)	0.07	(0.032)	J1E52-L12
	1 1/4	(32.0)	240	250	212	(33)	0.07	(0.032)	J1E88-L12
	1 1/2	(38.0)	120	50	32	(3)	0.08	(0.036)	J1J47-L12
	1 1/2	(38.0)	120	150	97	(15)	0.08	(0.036)	J1J48-L12
	1 1/2	(38.0)	240	150	97	(15)	0.08	(0.036)	J1J96-L12
	1 1/2	(38.0)	120	200	128	(20)	0.08	(0.036)	J1J59-L12
	1 1/2	(38.0)	240	200	128	(20)	0.08	(0.036)	J1J38-L12
	2	(51.0)	120	75	32	(5)	0.09	(0.041)	J2A80-L12
	2	(51.0)	120	200	86	(13)	0.09	(0.041)	J2A49-L12
	2	(51.0)	240	200	86	(13)	0.09	(0.041)	J2A75-L12
	2	(51.0)	120	250	108	(17)	0.09	(0.041)	J2A85-L12
	2	(51.0)	240	250	108	(17)	0.09	(0.041)	J2A71-L12
	2	(51.0)	120	300	128	(20)	0.09	(0.041)	J2A95-L12
	2	(51.0)	240	300	128	(20)	0.09	(0.041)	J2A96-L12
	2	(51.0)	120	400	171	(27)	0.09	(0.041)	J2A81-L12
	2	(51.0)	240	400	171	(27)	0.09	(0.041)	J2A82-L12
	2 1/4	(57.0)	120	75	28	(4)	0.10	(0.045)	J2E86-L12
	2 1/4	(57.0)	120	125	46	(7)	0.10	(0.045)	J2E87-L12
	2 1/4	(57.0)	120	250	92	(14)	0.10	(0.045)	J2E56-L12
	2 1/4	(57.0)	240	250	92	(14)	0.10	(0.045)	J2E69-L12
	2 1/4	(57.0)	120	400	147	(22)	0.10	(0.045)	J2E114-L12
	2 1/4	(57.0)	240	400	147	(22)	0.10	(0.045)	J2E115-L12
	2 1/4	(57.0)	120	500	184	(29)	0.10	(0.045)	J2E64-L12
	2 1/4	(57.0)	240	500	184	(29)	0.10	(0.045)	J2E88-L12
	2 1/2	(64.0)	120	100	32	(5)	0.11	(0.050)	J2J67-L12
	2 1/2	(64.0)	240	100	32	(5)	0.11	(0.050)	J2J57-L12
	2 1/2	(64.0)	120	250	81	(13)	0.11	(0.050)	J2J68-L12
	2 1/2	(64.0)	240	250	81	(13)	0.11	(0.050)	J2J69-L12
	2 1/2	(64.0)	120	300	96	(15)	0.11	(0.050)	J2J109-L12
	2 1/2	(64.0)	240	300	96	(15)	0.11	(0.050)	J2J110-L12
	2 1/2	(64.0)	120	400	128	(20)	0.11	(0.050)	J2J81-L12
	2 1/2	(64.0)	240	400	128	(20)	0.11	(0.050)	J2J82-L12
	2 1/2	(64.0)	120	500	161	(24)	0.11	(0.050)	J2J66-L12
	2 1/2	(64.0)	240	500	161	(24)	0.11	(0.050)	J2J70-L12
	2 3/4	(70.0)	240	400	115	(18)	0.11	(0.050)	J2N43-L12
	2 3/4	(70.0)	120	400	115	(18)	0.11	(0.050)	J2N45-L12
3	(76.0)	120	125	32	(5)	0.12	(0.054)	J3A108-L12	
3	(76.0)	240	125	32	(5)	0.12	(0.054)	J3A109-L12	
3	(76.0)	120	250	64	(10)	0.12	(0.054)	J3A107-L12	
3	(76.0)	240	250	64	(10)	0.12	(0.054)	J3A89-L12	
3	(76.0)	120	300	78	(12)	0.12	(0.054)	J3A65-L12	

CONTINUED

Heaters are manufactured to standard specifications. 12 inch crimped on GGS leads supplied. For other lead termination options, please contact your local Watlow representative.

Cartridge/Insertion Heaters



FIREROD Cartridge Heaters

Heater Part Numbers

Diameter in.	Sheath Length		Volts	Watts	Watt Density		Approx. Net Wt.		Part Number
	in.	(mm)			W/in ²	(W/cm ²)	lbs	(kg)	
1/2	3	(76.0)	120	350	89	(14)	0.12	(0.054)	J3A173-L12
	3	(76.0)	240	300	78	(12)	0.12	(0.054)	J3A73-L12
	3	(76.0)	120	400	104	(16)	0.12	(0.054)	J3A132-L12
	3	(76.0)	240	400	104	(16)	0.12	(0.054)	J3A29-L12
	3	(76.0)	120	500	129	(20)	0.12	(0.054)	J3A110-L12
	3	(76.0)	240	500	129	(20)	0.12	(0.054)	J3A111-L12
	3	(76.0)	120	600	154	(24)	0.12	(0.054)	J3A51-L12
	3	(76.0)	240	600	154	(24)	0.12	(0.054)	J3A127-L12
	3	(76.0)	120	750	193	(30)	0.12	(0.054)	J3A137-L12
	3	(76.0)	240	750	193	(30)	0.12	(0.054)	J3A112-L12
	3	(76.0)	120	1000	254	(39)	0.12	(0.054)	J3A79-L12
	3 1/2	(89.0)	120	250	54	(8)	0.14	(0.064)	J3J44-L12
	3 1/2	(89.0)	240	250	54	(8)	0.14	(0.064)	J3J64-L12
	3 1/2	(89.0)	240	350	75	(12)	0.14	(0.064)	J3J65-L12
	3 1/2	(89.0)	120	500	107	(17)	0.14	(0.064)	J3J45-L12
	3 1/2	(89.0)	240	500	107	(17)	0.14	(0.064)	J3J46-L12
	3 1/2	(89.0)	240	750	162	(25)	0.14	(0.064)	J3J63-L12
	4	(102.0)	120	150	28	(4)	0.15	(0.068)	J4A117-L12
	4	(102.0)	240	150	28	(4)	0.15	(0.068)	J4A122-L12
	4	(102.0)	120	250	46	(7)	0.15	(0.068)	J4A118-L12
4	(102.0)	240	250	46	(7)	0.15	(0.068)	J4A90-L12	
4	(102.0)	120	300	56	(9)	0.15	(0.068)	J4A63-L12	
4	(102.0)	240	300	56	(9)	0.15	(0.068)	J4A26-L12	
4	(102.0)	120	350	65	(10)	0.15	(0.068)	J4A1-L12	
4	(102.0)	240	350	65	(10)	0.15	(0.068)	J4A103-L12	
4	(102.0)	120	400	74	(11)	0.15	(0.068)	J4A139-L12	
4	(102.0)	240	400	74	(11)	0.15	(0.068)	J4A68-L12	
4	(102.0)	120	500	92	(14)	0.15	(0.068)	J4A16-L12	
4	(102.0)	120	550	100	(16)	0.15	(0.068)	J4A242-L12	
4	(102.0)	240	500	92	(14)	0.15	(0.068)	J4A92-L12	
4	(102.0)	120	750	138	(21)	0.15	(0.068)	J4A198-L12	
4	(102.0)	240	750	138	(21)	0.15	(0.068)	J4A119-L12	
4	(102.0)	240	1000	184	(28)	0.15	(0.068)	J4A73-L12	
4 1/2	(114.0)	120	500	80	(12)	0.17	(0.077)	J4J69-L12	
4 1/2	(114.0)	240	500	80	(12)	0.17	(0.077)	J4J57-L12	
4 1/2	(114.0)	120	750	120	(19)	0.17	(0.077)	J4J70-L12	
4 1/2	(114.0)	240	750	120	(19)	0.17	(0.077)	J4J32-L12	
5	(127.0)	120	200	29	(4)	0.19	(0.086)	J5A85-L12	
5	(127.0)	240	200	29	(4)	0.19	(0.086)	J5A74-L12	
5	(127.0)	120	350	50	(8)	0.19	(0.086)	J5A86-L12	
5	(127.0)	240	350	50	(8)	0.19	(0.086)	J5A63-L12	
5	(127.0)	120	400	58	(9)	0.19	(0.086)	J5A98-L12	
5	(127.0)	240	400	58	(9)	0.19	(0.086)	J5A46-L12	
5	(127.0)	120	500	72	(11)	0.19	(0.086)	J5A52-L12	
5	(127.0)	240	500	72	(11)	0.19	(0.086)	J5A45-L12	
5	(127.0)	120	750	108	(17)	0.19	(0.086)	J5A121-L12	
5	(127.0)	240	750	108	(17)	0.19	(0.086)	J5A72-L12	
5	(127.0)	240	1000	143	(22)	0.19	(0.086)	J5A87-L12	
5 1/2	(140.0)	240	200	25	(4)	0.20	(0.091)	J5J38-L12	
5 1/2	(140.0)	120	500	64	(10)	0.20	(0.091)	J5J43-L12	
5 1/2	(140.0)	240	500	64	(10)	0.20	(0.091)	J5J33-L12	
5 1/2	(140.0)	240	650	83	(13)	0.20	(0.091)	J5J69-L12	

CONTINUED

Heaters are manufactured to standard specifications. 12 inch crimped on GGS leads supplied. For other lead termination options, please contact your local Watlow representative.

Cartridge/Insertion Heaters



FIREROD Cartridge Heaters

Heater Part Numbers

Diameter in.	Sheath Length		Volts	Watts	Watt Density		Approx. Net Wt.		Part Number
	in.	(mm)			W/in ²	(W/cm ²)	lbs	(kg)	
1/2	5 1/2	(140.0)	120	750	97	(15)	0.20	(0.091)	J5J44-L12
	5 1/2	(140.0)	240	750	97	(15)	0.20	(0.091)	J5J45-L12
	5 3/4	(146.0)	120	700	86	(13)	0.20	(0.091)	J5N6-L12
	5 3/4	(146.0)	240	700	86	(13)	0.20	(0.091)	J5N8-L12
	6	(152.0)	120	250	29	(4)	0.21	(0.095)	J6A114-L12
	6	(152.0)	240	250	29	(4)	0.21	(0.095)	J6A171-L12
	6	(152.0)	240	300	35	(6)	0.21	(0.095)	J6A66-L12
	6	(152.0)	240	350	41	(7)	0.21	(0.095)	J6A119-L12
	6	(152.0)	120	500	59	(9)	0.21	(0.095)	J6A115-L12
	6	(152.0)	240	500	59	(9)	0.21	(0.095)	J6A94-L12
	6	(152.0)	120	750	88	(14)	0.21	(0.095)	J6A99-L12
	6	(152.0)	240	750	88	(14)	0.21	(0.095)	J6A90-L12
	6	(152.0)	120	1000	117	(18)	0.21	(0.095)	J6A53-L12
	6	(152.0)	240	1000	117	(18)	0.21	(0.095)	J6A36-L12
	6 1/2	(165.0)	240	500	54	(8)	0.23	(0.104)	J6J45-L12
	6 1/2	(165.0)	240	1000	108	(17)	0.23	(0.104)	J6J27-L12
	7	(178.0)	120	250	25	(4)	0.24	(0.109)	J7A79-L12
	7	(178.0)	120	500	50	(8)	0.24	(0.109)	J7A80-L12
	7	(178.0)	240	500	50	(8)	0.24	(0.109)	J7A57-L12
	7	(178.0)	120	600	60	(9)	0.24	(0.109)	J7A50-L12
	7	(178.0)	240	600	60	(9)	0.24	(0.109)	J7A95-L12
	7	(178.0)	240	1000	99	(15)	0.24	(0.109)	J7A81-L12
	7 1/2	(191.0)	240	500	46	(7)	0.26	(0.118)	J7J25-L12
	7 1/2	(191.0)	240	1000	92	(14)	0.26	(0.118)	J7J26-L12
	8	(203.0)	120	300	26	(4)	0.28	(0.127)	J8A71-L12
	8	(203.0)	240	300	26	(4)	0.28	(0.127)	J8A111-L12
	8	(203.0)	120	500	43	(7)	0.28	(0.127)	J8A64-L12
	8	(203.0)	240	500	43	(7)	0.28	(0.127)	J8A66-L12
	8	(203.0)	120	1000	86	(13)	0.28	(0.127)	J8A84-L12
	8	(203.0)	240	1000	86	(13)	0.28	(0.127)	J8A60-L12
	8	(203.0)	240	1500	129	(20)	0.28	(0.127)	J8A100-L12
	8	(203.0)	240	2000	172	(27)	0.28	(0.127)	J8A101-L12
	8 1/2	(216.0)	240	300	24	(4)	0.29	(0.132)	J8J39-L12
	8 1/2	(216.0)	240	500	40	(6)	0.29	(0.132)	J8J30-L12
	8 1/2	(216.0)	240	1000	80	(12)	0.29	(0.132)	J8J28-L12
	9	(229.0)	240	500	38	(6)	0.30	(0.136)	J9A35-L12
	9	(229.0)	240	1000	76	(12)	0.30	(0.136)	J9A58-L12
	9 1/2	(241.0)	240	500	36	(6)	0.32	(0.145)	J9J14-L12
	9 1/2	(241.0)	240	1000	72	(11)	0.32	(0.145)	J9J12-L12
	10	(254.0)	120	500	34	(5)	0.33	(0.150)	J10A61-L12
	10	(254.0)	240	500	34	(5)	0.33	(0.150)	J10A62-L12
	10	(254.0)	120	1000	68	(11)	0.33	(0.150)	J10A63-L12
	10	(254.0)	240	1000	68	(11)	0.33	(0.150)	J10A42-L12
	10	(254.0)	240	1500	102	(16)	0.33	(0.150)	J10A33-L12
	10	(254.0)	240	2000	136	(21)	0.33	(0.150)	J10A64-L12
	11	(279.0)	240	1000	61	(9)	0.36	(0.163)	J11A60-L12
	12	(305.0)	120	500	28	(4)	0.40	(0.181)	J12A63-L12
	12	(305.0)	240	500	28	(4)	0.40	(0.181)	J12A76-L12
	12	(305.0)	120	1000	56	(9)	0.40	(0.181)	J12A40-L12
	12	(305.0)	240	1000	56	(9)	0.40	(0.181)	J12A49-L12
12	(305.0)	240	1500	84	(13)	0.40	(0.181)	J12A37-L12	
12	(305.0)	240	2000	112	(17)	0.40	(0.181)	J12A89-L12	
14	(356.0)	240	1000	48	(7)	0.48	(0.218)	J14A41-L12	

CONTINUED

Heaters are manufactured to standard specifications. 12 inch crimped on GGS leads supplied. For other lead termination options, please contact your local Watlow representative.

Cartridge/Insertion Heaters



FIREROD Cartridge Heaters

Heater Part Numbers

Diameter in.	Sheath Length		Volts	Watts	Watt Density		Approx. Net Wt.		Part Number
	in.	(mm)			W/in ²	(W/cm ²)	lbs	(kg)	
1/2	14	(356.0)	240	2300	110	(17)	0.48	(0.218)	J14A39-L12
	15	(381.0)	240	1500	66	(10)	0.50	(0.227)	J15A19-L12
	16	(406.0)	240	1000	41	(7)	0.52	(0.236)	J16A12-L12
	18	(457.0)	240	1500	55	(9)	0.57	(0.259)	J18A19-L12
	18	(457.0)	240	1700	62	(9)	0.57	(0.259)	J18A23-L12
5/8	1 1/4	(32.0)	120	50	34	(5)	0.10	(0.045)	L1E26-L12
	1 1/4	(32.0)	120	200	137	(21)	0.10	(0.045)	L1E24-L12
	1 1/4	(32.0)	120	250	171	(27)	0.10	(0.045)	L1E27-L12
	1 1/2	(38.0)	120	250	128	(20)	0.11	(0.050)	L1J23-L12
	1 1/2	(38.0)	240	250	128	(20)	0.11	(0.050)	L1J24-L12
	2	(51.0)	120	100	34	(5)	0.13	(0.059)	L2A48-L12
	2	(51.0)	120	200	68	(11)	0.13	(0.059)	L2A49-L12
	2	(51.0)	240	500	170	(26)	0.13	(0.059)	L2A54-L12
	2 1/4	(57.0)	120	100	29	(4)	0.14	(0.064)	L2E49-L12
	2 1/4	(57.0)	120	250	73	(11)	0.14	(0.064)	L2E50-L12
	2 1/4	(57.0)	240	250	73	(11)	0.14	(0.064)	L2E12-L12
	2 1/4	(57.0)	120	350	103	(16)	0.14	(0.064)	L2E40-L12
	2 1/4	(57.0)	240	350	103	(16)	0.14	(0.064)	L2E51-L12
	3	(76.0)	120	150	31	(5)	0.20	(0.091)	L3A81-L12
	3	(76.0)	120	250	51	(8)	0.20	(0.091)	L3A82-L12
	3	(76.0)	240	250	51	(8)	0.20	(0.091)	L3A9-L12
	3	(76.0)	120	400	81	(13)	0.20	(0.091)	L3A94-L12
	3	(76.0)	120	500	102	(16)	0.20	(0.091)	L3A113-L12
	3	(76.0)	240	500	103	(16)	0.20	(0.091)	L3A33-L12
	3	(76.0)	240	750	154	(24)	0.20	(0.091)	L3A71-L12
	3 3/4	(95.0)	120	525	82	(13)	0.24	(0.109)	L3N12-L12
	3 3/4	(95.0)	240	525	82	(13)	0.24	(0.109)	L3N1-L12
	4	(102.0)	120	250	37	(6)	0.26	(0.118)	L4A99-L12
	4	(102.0)	240	250	37	(6)	0.26	(0.118)	L4A104-L12
	4	(102.0)	240	400	58	(9)	0.26	(0.118)	L4A47-L12
	4	(102.0)	240	500	73	(11)	0.26	(0.118)	L4A53-L12
	4	(102.0)	240	600	88	(14)	0.26	(0.118)	L4A44-L12
	4	(102.0)	240	750	110	(17)	0.26	(0.118)	L4A100-L12
	4	(102.0)	240	1000	146	(23)	0.26	(0.118)	L4A71-L12
	5	(127.0)	120	250	28	(4)	0.29	(0.132)	L5A76-L12
	5	(127.0)	240	250	28	(4)	0.29	(0.132)	L5A107-L12
	5	(127.0)	240	500	57	(9)	0.29	(0.132)	L5A24-L12
	5	(127.0)	240	750	86	(13)	0.29	(0.132)	L5A31-L12
	5	(127.0)	240	1000	114	(18)	0.29	(0.132)	L5A77-L12
	6	(152.0)	120	300	28	(4)	0.34	(0.154)	L6A28-L12
	6	(152.0)	240	300	28	(4)	0.34	(0.154)	L6A64-L12
	6	(152.0)	240	500	47	(7)	0.34	(0.154)	L6A73-L12
	6	(152.0)	240	750	70	(11)	0.34	(0.154)	L6A70-L12
	6	(152.0)	240	1000	93	(14)	0.34	(0.154)	L6A71-L12
	6	(152.0)	120	1500	139	(22)	0.34	(0.154)	L6A163-L12
6	(152.0)	240	1500	140	(22)	0.34	(0.154)	L6A94-L12	
6 1/2	(165.0)	120	500	43	(7)	0.38	(0.172)	L6J43-L12	
6 1/2	(165.0)	240	500	43	(7)	0.38	(0.172)	L6J55-L12	
7	(178.0)	120	500	39	(6)	0.40	(0.181)	L7A42-L12	
7	(178.0)	240	500	39	(6)	0.40	(0.181)	L7A15-L12	
7	(178.0)	240	1000	79	(12)	0.40	(0.181)	L7A37-L12	
7	(178.0)	240	1500	118	(18)	0.40	(0.181)	L7A12-L12	

CONTINUED

Heaters are manufactured to standard specifications. 12 inch crimped on GGS leads supplied. For other lead termination options, please contact your local Watlow representative.

Cartridge/Insertion Heaters



FIREROD Cartridge Heaters

Heater Part Numbers

Diameter in.	Sheath Length		Volts	Watts	Watt Density		Approx. Net Wt.		Part Number
	in.	(mm)			W/in ²	(W/cm ²)	lbs	(kg)	
5/8	8	(203.0)	120	500	34	(5)	0.47	(0.213)	L8A96-L12
	8	(203.0)	240	500	34	(5)	0.47	(0.213)	L8A46-L12
	8	(203.0)	240	850	58	(9)	0.47	(0.213)	L8A115-L12
	8	(203.0)	240	1000	68	(10)	0.47	(0.213)	L8A10-L12
	8	(203.0)	240	1500	102	(16)	0.47	(0.213)	L8A37-L12
	8	(203.0)	240	2000	137	(21)	0.47	(0.213)	L8A80-L12
	10	(254.0)	120	500	27	(4)	0.53	(0.240)	L10A51-L12
	10	(254.0)	240	500	27	(4)	0.53	(0.240)	L10A40-L12
	10	(254.0)	240	750	40	(6)	0.53	(0.240)	L10A69-L12
	10	(254.0)	240	1000	54	(8)	0.53	(0.240)	L10A52-L12
	10	(254.0)	480	1000	54	(8)	0.53	(0.240)	L10A193-L12
	10	(254.0)	240	1500	81	(13)	0.53	(0.240)	L10A8-L12
	10	(254.0)	240	2000	108	(17)	0.53	(0.240)	L10A50-L12
	12	(305.0)	120	500	22	(3)	0.66	(0.300)	L12A81-L12
	12	(305.0)	240	500	22	(3)	0.66	(0.300)	L12A80-L12
	12	(305.0)	240	900	40	(6)	0.66	(0.300)	L12A102-L12
	12	(305.0)	120	1000	45	(7)	0.66	(0.300)	L12A82-L12
	12	(305.0)	240	1000	45	(7)	0.66	(0.300)	L12A34-L12
	12	(305.0)	120	1500	66	(10)	0.66	(0.300)	L12A147-L12
	12	(305.0)	240	1500	67	(10)	0.66	(0.300)	L12A39-L12
	12	(305.0)	240	2000	89	(14)	0.66	(0.300)	L12A63-L12
	14	(356.0)	240	3700	140	(22)	0.79	(0.358)	L14A21-L12
	15	(381.0)	240	750	27	(4)	0.84	(0.381)	L15A35-L12
	15	(381.0)	240	2400	84	(13)	0.84	(0.381)	L15A20-L12
	15	(381.0)	480	2500	88	(14)	0.84	(0.381)	L15A88-L12
	15	(381.0)	240	4000	141	(22)	0.84	(0.381)	L15A41-L12
	16	(406.0)	240	2500	82	(13)	0.91	(0.412)	L16A33-L12
	16	(406.0)	240	4500	148	(23)	0.91	(0.412)	L16A40-L12
	18	(457.0)	240	1500	44	(7)	1.03	(0.467)	L18A32-L12
	18	(457.0)	240	3000	87	(13)	1.03	(0.467)	L18A34-L12
	18	(457.0)	240	4700	137	(21)	1.03	(0.467)	L18A36-L12
	20	(508.0)	240	1500	40	(6)	1.25	(0.567)	L20A19-L12
20	(508.0)	240	3500	92	(14)	1.25	(0.567)	L20A13-L12	
20	(508.0)	480	3500	92	(14)	1.25	(0.567)	L20A96-L12	
20	(508.0)	240	4700	123	(19)	1.25	(0.567)	L20A14-L12	
24	(610.0)	240	2000	44	(7)	1.47	(0.667)	L24A19-L12	
24	(610.0)	240	4700	102	(15)	1.47	(0.667)	L24A14-L12	
36	(914.0)	240	3000	43	(7)	2.30	(1.04)	L36A8-L12	
3/4	2 1/4	(57.0)	120	200	49	(8)	0.19	(0.086)	N2E8-L12
	3	(76.0)	120	250	43	(7)	0.24	(0.109)	N3A11-L12
	3	(76.0)	240	500	85	(13)	0.24	(0.109)	N3A12-L12
	4	(102.0)	120	250	31	(5)	0.31	(0.141)	N4A16-L12
	4	(102.0)	240	500	61	(9)	0.31	(0.141)	N4A17-L12
	4	(102.0)	240	1000	122	(19)	0.31	(0.141)	N4A15-L12
	5	(127.0)	120	300	28	(4)	0.38	(0.172)	N5A19-L12
	5	(127.0)	240	500	47	(7)	0.38	(0.172)	N5A12-L12
	5	(127.0)	240	1000	95	(15)	0.38	(0.172)	N5A20-L12
	6	(152.0)	120	500	39	(6)	0.44	(0.200)	N6A19-L12
	6	(152.0)	240	500	39	(6)	0.44	(0.200)	N6A20-L12
	6	(152.0)	240	1000	78	(12)	0.44	(0.200)	N6A21-L12
	6	(152.0)	480	1000	78	(12)	0.44	(0.200)	N6A225-L12

CONTINUED

Heaters are manufactured to standard specifications. 12 inch crimped on GGS leads supplied. For other lead termination options, please contact your local Watlow representative.



FIREROD Cartridge Heaters

Heater Part Numbers

Diameter in.	Sheath Length		Volts	Watts	Watt Density		Approx. Net Wt.		Part Number
	in.	(mm)			W/in ²	(W/cm ²)	lbs	(kg)	
3/4	6	(152.0)	240	1500	116	(18)	0.44	(0.200)	N6A82-L12
	6	(152.0)	240	2000	155	(24)	0.44	(0.200)	N6A22-L12
	7	(178.0)	120	500	33	(5)	0.51	(0.231)	N7A15-L12
	7	(178.0)	240	500	33	(5)	0.51	(0.231)	N7A1-L12
	7	(178.0)	240	1000	66	(10)	0.51	(0.231)	N7A16-L12
	8	(203.0)	120	500	28	(4)	0.58	(0.263)	N8A19-L12
	8	(203.0)	240	500	28	(4)	0.58	(0.263)	N8A20-L12
	8	(203.0)	240	1000	57	(9)	0.58	(0.263)	N8A21-L12
	8	(203.0)	240	2000	114	(17)	0.58	(0.263)	N8A22-L12
	10	(254.0)	240	1000	45	(7)	0.72	(0.327)	N10A15-L12
	10	(254.0)	240	2000	90	(14)	0.72	(0.327)	N10A14-L12
	12	(305.0)	240	1000	37	(6)	0.84	(0.381)	N12A15-L12
	12	(305.0)	240	2000	74	(11)	0.84	(0.381)	N12A24-L12
	12	(305.0)	480	2000	74	(11)	0.84	(0.381)	N12A198-L12
	12	(305.0)	240	4000	148	(23)	0.84	(0.381)	N12A25-L12
	13	(330.0)	240	1000	34	(5)	0.93	(0.422)	N13A26-L12
	14	(356.0)	240	1250	40	(6)	1.03	(0.467)	N14A22-L12
	14	(356.0)	240	2500	79	(12)	1.03	(0.467)	N14A20-L12
	14	(356.0)	240	4500	142	(22)	1.03	(0.467)	N14A21-L12
	15	(381.0)	240	1500	44	(7)	1.09	(0.494)	N15A26-L12
	16	(406.0)	240	1800	49	(8)	1.14	(0.517)	N16A26-L12
	16	(406.0)	240	4700	129	(20)	1.14	(0.517)	N16A18-L12
	18	(457.0)	240	2000	49	(8)	1.25	(0.567)	N18A13-L12
	18	(457.0)	240	5000	122	(19)	1.25	(0.567)	N18A15-L12
	20	(508.0)	240	1150	25	(4)	1.40	(0.635)	N20A21-L12
	20	(508.0)	240	2250	49	(8)	1.40	(0.635)	N20A22-L12
	20	(508.0)	240	5250	115	(18)	1.40	(0.635)	N20A10-L12
	24	(610.0)	240	1375	25	(4)	1.80	(0.816)	N24A24-L12
	24	(610.0)	240	2750	50	(8)	1.80	(0.816)	N24A23-L12
	24	(610.0)	480	2750	50	(8)	1.80	(0.816)	N24A78-L12
24	(610.0)	240	5500	100	(16)	1.80	(0.816)	N24A13-L12	
36	(914.0)	240	2500	30	(6)	2.50	(1.13)	N36A4-L12	

Heaters are manufactured to standard specifications. 12 inch crimped on GGS leads supplied. For other lead termination options, please contact your local Watlow representative.

Cartridge/Insertion Heaters



Metric FIREROD Cartridge Heaters

The Watlow FIREROD not only sets the industry standard for cartridge heaters, but continues to make improvements in construction and design. Among those improvements is the metric FIREROD, a variation of the FIREROD cartridge heater built to meet the exact specifications of the global market.

Like its counterpart, the metric FIREROD consistently outperforms other cartridge heaters with its design solutions such as its exclusive resistance wire winding and swaging process. These processes bring the resistance wire closer to the sheath and compacts the MgO insulation to maximize heat transfer. The end result is longer service life and better efficiency.

Performance Capabilities

- Part temperatures up to 760°C (1400°F) on alloy 800 sheath
- Watt densities up to 50 W/cm² (330 W/in²)

Features and Benefits

Nickel-chromium resistance wire

- Assures even and efficient distribution of heat to the sheath because the wire is precisely wound and centered in the heater

Metalurgically-bonded conductor pins

- Ensures a trouble-free electrical connection

Magnesium oxide insulation of specific grain and purity

- Results in high dielectric strength and contributes to faster heat-up

Alloy 800 sheath

- Resists oxidation and corrosion from many chemicals, heat or atmospheres

Minimal spacing between the element wire and sheath

- Results in lower internal temperature
- Accommodates a design with fewer or smaller heaters operating at higher watt densities

UL® and CSA approved flexible stranded wires

- Lead insulation rated to temperatures up to 840°F (450°C)

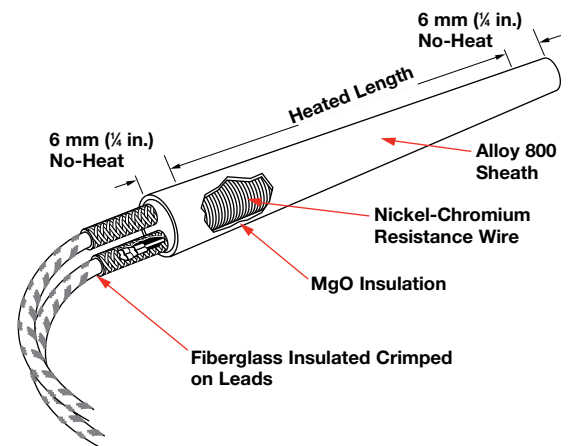
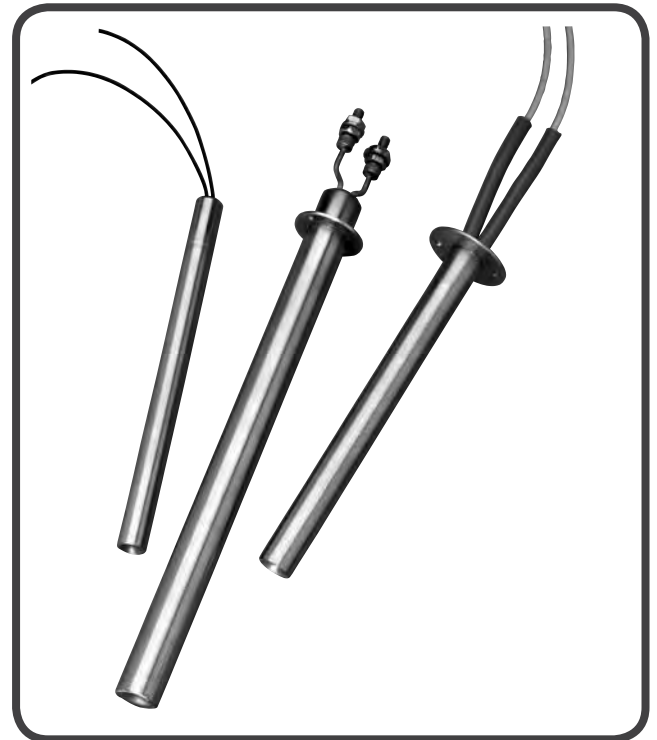

Typical Applications

- Semiconductor chamber heating
- Semiconductor wafer lead connection
- Semiconductor wire and die bonding
- Freeze protection and deicing of equipment in cold climates or applications
- Humidity control
- Patient comfort heating used in medical devices
- Mold die and platen heating
- Seal bars used in packaging equipment
- Test sample heating in gas chromatography equipment

Cartridge/Insertion Heaters



Metric FIREROD Cartridge Heaters

Applications and Technical Data

The *Electrical Data* table will assist you in selecting the correct metric FIREROD heater for your application, according to available voltage, amperage and wattage.

Electrical Data

Heater Diameter (mm)	6.5	8	10	12.5	16	20
Nominal Diameter (in.)	0.256	0.315	0.394	0.492	0.630	0.787
Max. Voltage	250	250	250	400	480	480
Crimped on Leads						
Max. Amperes	7.2	7.2	16.1	16.1	21	21
Max. Wattage @ 230V	1650	1650	3700	3700	4830	4830
Max. Wattage @ 400V				6440	8400	8400
Swaged-in Leads						
Max. Amperes	5.2/7.2 ^①	5.2/7.2 ^①	12.6	12.6	12.6/21 ^①	21
Max. Wattage @ 230V	1190/1650	1190/1650	2890	2890	2890/4830	4830
Max. Wattage @ 400V	—	—	—	5040	5040/8400	8400

^①On certain lead constructions, maximum amperes are 5.2 or 12.6. In these instances, amperes are determined by internal construction and current carrying capacity of internal parts to the lead wire. For more information about these amperes restrictions or higher current requirements, please contact your Watlow representative.

Tolerances

Diameter: -0.02 mm, -0.12 mm (-0.0008 in., -0.0047 in.)

Length: ±2% with ±2.4 mm (±³/₃₂ in.) min.

Wattage: +5%, -10%, wattage decreases approximately 5% with temperature. Wattage tolerances are for heaters at operating temperature.

Resistance: +10%, -5%, resistance is measured at room temperature following first heater operation.

Camber: 0.25 mm (0.01 in.) max. on any length to 300 mm (12 in.). For lengths over 300 mm:

$$\frac{[\text{Heater Length (mm)}]^2}{182,900}$$

Cartridge/Insertion Heaters



Metric FIREROD Cartridge Heaters

Maximum Allowable Watt Density

The following four graphs detail maximum allowable watt densities for applications involving metal heating or steam, air and gas heating. Please review these respective graphs and applicable data to determine the correct watt density for the application.

Heating Metals

The *Maximum Watt Density—Heating Metals* graph will show either the maximum hole fit or recommended watt density of the heater. Enter the chart with either known variable, part fit in hole dimension or watt density. Then, find the application temperature by reading up or over on the chart.

If the fit of the heater in the hole dimension is not known, it is easily determined. Subtract the minimum diameter of the metric FIREROD (nominal diameter minus tolerance) from the maximum hole diameter. For example, take a hole diameter of 16.1 mm minus a heater diameter of 16 mm - 0.12 mm. The hole fit would be 0.22 mm. For metric FIREROD heaters in square holes or grooves, contact your Watlow representative for fit in hole dimension.

Correction Factors:

Also note, the *Maximum Watt Density—Heating Metals* graph depicts metric FIRERODs used in steel parts. Therefore, for either stainless steel, aluminum or brass, refer to applicable correction factors ^① and ^②.

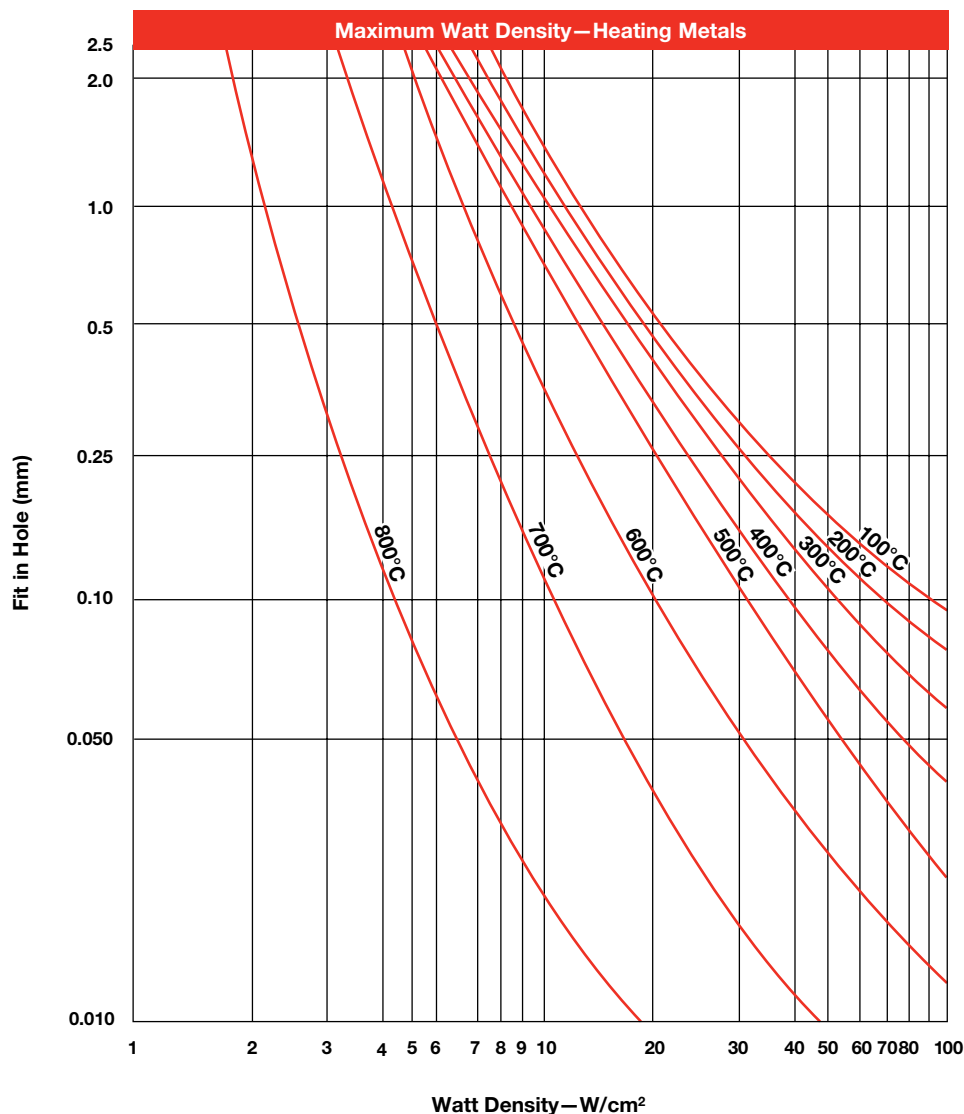

^① For SS, enter the graph with a fit 0.04 mm (0.0015 in.) larger than actual.

^② For aluminum and brass, enter the graph with a temperature 55°C (100°F) above actual temperature.

Cartridge/Insertion Heaters



Metric FIREROD Cartridge Heaters

Maximum Allowable Watt Density (Continued)

Watt Density vs. Ambient Air

The *Watt Density vs. Ambient Air Temperature* graph shows the maximum allowable watt density when one metric FIREROD heater is operated in air or similar gas. For metric FIRERODs grouped in a single row, with no less than one diameter between elements, multiply value from graph by 0.95. When a reflector is placed behind the heaters, multiply the maximum allowable watt density value from the graph by 0.85.

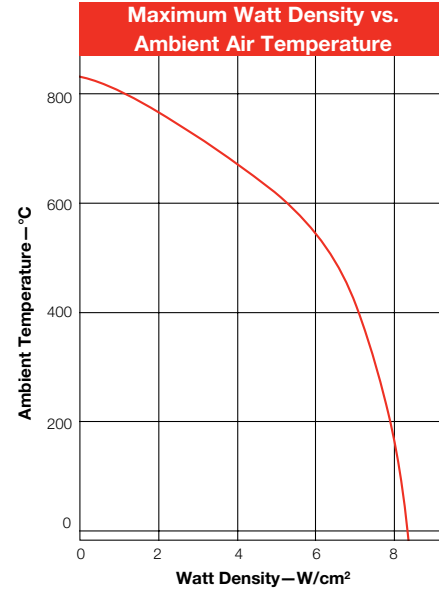

Sheath Temperature in Ambient Air

The *Sheath Temperature in Ambient Air* graph indicates the watt density required to bring a metric FIREROD heater to a given sheath temperature when operated in 20°C (70°F) ambient air.

At 7 W/cm² (44 W/in²), the sheath temperature will be 790°C (1450°F). At this temperature, one year of heater life would be expected, provided cycling is not too frequent. Higher temperatures would result in reduced heater life.

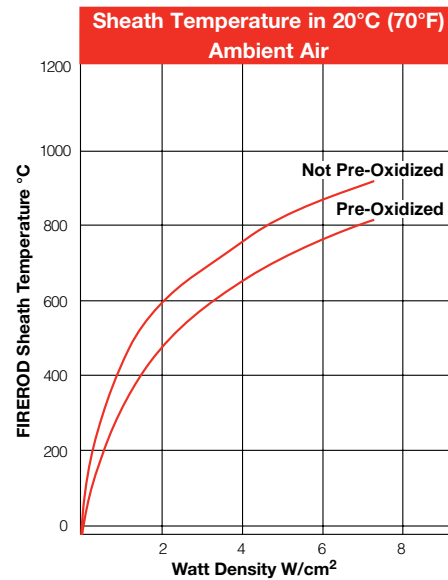

Watt Density in Moving Air

The *Watt Density in Moving Air* graph gives the maximum allowable watt density of a metric FIREROD heater in moving air.

If the volumetric flow rate of air is known in m³/s (or CFM), divide this value by the net free area in m² (or ft²) around the heater to determine air flow velocity. The net free area is the total area of the enclosure minus the area occupied by the heater.

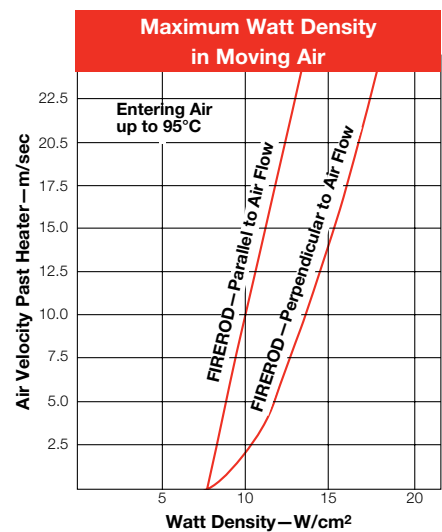

Cartridge/Insertion Heaters



Metric FIREROD Cartridge Heaters

Termination Options

Swaged-in Flexible Leads

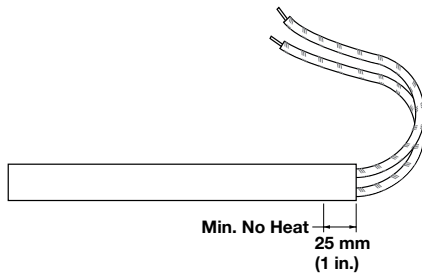

Swaged-in flexible leads, with silicone-fiberglass insulation, are recommended for applications in which the leads must be bent at the exit point from the heater. Unless longer length is specified, 250 mm (10 in.) leads are supplied.

Heaters 150 mm (6 in.) or shorter generally have a 6 mm (1/4 in.) no-heat section. Heaters up to 250 mm (10 in.) require a 25 mm (1 in.) no-heat section. Heaters greater than 250 mm may require more than a 25 mm no-heat section. To order, please specify **swaged-in flexible leads**.

Right Angle Leads



Right angle leads are used in applications with a high degree of flexing and when space limitations are critical. Lead wires exit at a 90° angle through the side of the heater sheath. Right angle tube may be necessary on certain constructions. To order, specify **right angle leads** and lead length.

Metric FIREROD Diameter mm	Min No-Heat Length mm (in.)
6.5	15 (9/16)
8.0	15 (9/16)
10.0	17 (2/3)
12.5	18 (11/16)
16.0	20 (3/4)
20.0	21 (13/16)

Stainless Steel Braid

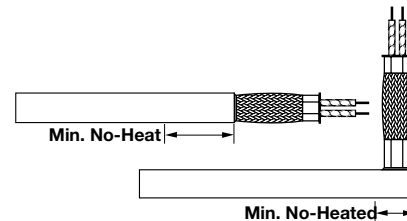

A stainless steel braid is designed to protect leads from abrasion against sharp edges. It is the most flexible of Watlow's protective lead arrangements.

When the leads exit straight out, the braid is swaged into the no-heat section of the heater. When the leads exit at a right angle, a crimp connector is used to attach the braids.

Unless otherwise specified, leads are 250 mm (10 in.) and the braid is 200 mm (8 in.) long. To order, specify either **straight or right angle stainless steel braid**, lead length and no-heat section.

Metric FIREROD Diameter mm	Min. No-Heat Length	
	Straight mm (in.)	Right Angle mm (in.)
6.5	30 (1 1/8)	N/A
8.0	30 (1 1/8)	15 (9/16)
10.0	30 (1 1/8)	17 (2/3)
12.5	30 (1 1/8)	18 (1 1/16)
16.0	30 (1 1/8)	20 (3/4)
20.0	30 (1 1/8)	21 (1 3/16)

Ceramic Bead Insulation

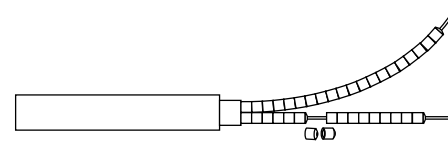

Ceramic bead insulation protects the leads from high temperature ambients above 450°C (840°F). The beads fit over solid conductors and are extended long enough to reach a cooler area where flexible wires can be attached. To order, specify **ceramic beads** and length, and additional lead length.

Cartridge/Insertion Heaters



Metric FIREROD Cartridge Heaters

Termination Options (Continued)

Stainless Steel Hose

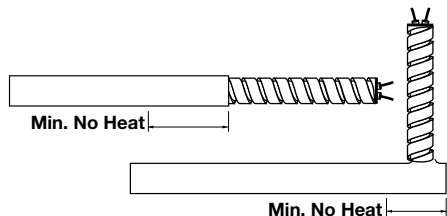

Stainless steel hose provides the best protection against abrasion from sharp edges or abrasive equipment. It also offers ease of handling and wiring in abrasive environments.

When the leads exit at a right angle to the heater, the hose is silver soldered to the sheath. Unless otherwise specified, leads are 250 mm (10 in.) long and the hose is 200 mm (8 in.) long. To order, specify **stainless steel hose**, lead length and no-heat section.

Metric FIREROD Diameter mm	Min. No-Heat Length		SS Hose O.D. mm (in.)
	Straight mm (in.)	Right Angle mm (in.)	
6.5	30 (1 ¹ / ₈)	N/A	4.7 (3 ¹ / ₁₆)
8.0	30 (1 ¹ / ₈)	15 (9 ¹ / ₁₆)	5.7 (7 ¹ / ₃₂)
10.0	30 (1 ¹ / ₈)	17 (2 ¹ / ₈)	7.6 (3 ¹ / ₁₀)
12.5	30 (1 ¹ / ₈)	18 (1 ¹ / ₁₆)	9.5 (3 ⁷ / ₈)
16.0	30 (1 ¹ / ₈)	20 (3 ¹ / ₄)	12.7 (1 ¹ / ₂)
20.0	30 (1 ¹ / ₈)	21 (1 ³ / ₁₆)	15.8 (5 ¹ / ₈)

PTFE Seal and Leads

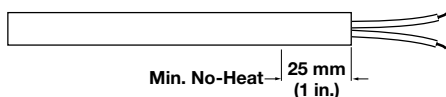

PTFE seal and leads protect the heater against moisture and contamination from lubricating oil, cleaning solvents, plastic material or fumes and organic tapes. This seal is effective to 200°C (400°F) under continuous operation.

Please note, when ordering this option, that a 25 mm (1 in.) minimum no-heat section is required to allow construction. Additional no-heat area may be required to keep the seal below effective temperatures. To order, specify **PTFE seal and leads** and lead length.

Silicone Rubber Seal and Leads

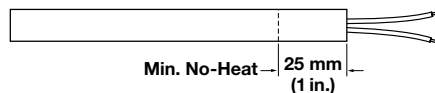

Silicone rubber seals and leads protect the heater against moisture and contamination from lubricating oil, cleaning solvents, plastic material or fumes and organic tapes. This seal is effective to 230°C (450°F) under continuous operation. Epoxy potting for up to 260°C (500°F) for continuous operation is available upon request.

Please note, when ordering this option, a 25 mm (1 in.) minimum no-heat section is required to allow for construction. Additional no-heat may be required to keep the seal below effective temperatures. To order, specify **silicone rubber seal and leads** and lead length.

No-Heat Section

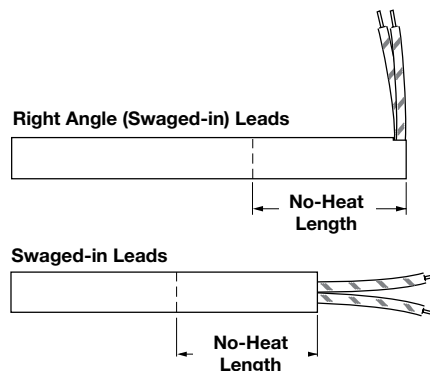

No-heat sections are recommended in applications where leads may be exposed to excessive heat, thus requiring a cooler lead end. Also use when heat is not required along the entire length of the metric FIREROD. No-heat extensions are available on all diameters with both pin style and swaged-in leads. To order, specify **no-heat** section and length of no-heat.

Cartridge/Insertion Heaters



Metric FIREROD Cartridge Heaters

Termination Options (Continued)

Ground Lead

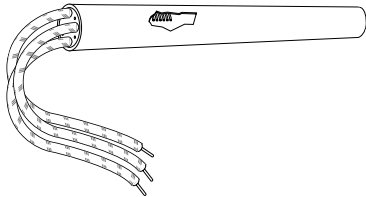

Ground leads are a safety feature to protect both workers and equipment. This configuration is not available on all options. Contact your Watlow representative for additional information. To order, specify **ground lead**.

Options

Distributed Wattage

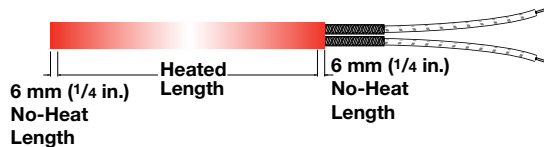

Distributed wattage varies the watt density along the length of the heater. This construction technique is used to compensate for heat losses along the edges of heated parts. To order, specify **distributed wattage** and give the length and wattage for each section.

Options (Continued)

Internal Thermocouple Sensors

Style A

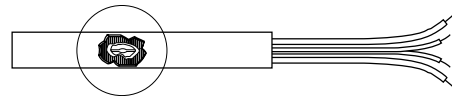

Style B

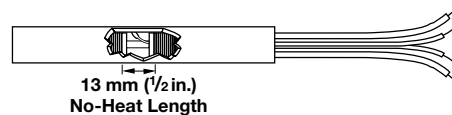

Style C

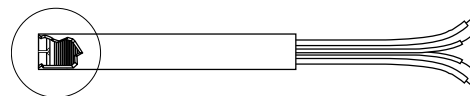

The **Style A** internal thermocouple can be used to evaluate heat transfer efficiency of an application, a measure enabling a customer to cut energy costs and increase heater life.

The **Style B** internal thermocouple gives a good approximation of part temperature. The thermocouple junction is in contact with the inside of the heater sheath, located in the 13 mm (1/2 in.) no-heat section anywhere along the heater length.

A **Style C** internal thermocouple is useful in applications where material flows past the end of the heater, as in plastic molding. This junction is embedded in a special end disc. Style C is not available on 20 mm (0.8 in.) diameter units. Unless requested, the disc end is not mechanically sealed.

To order, specify **internal thermocouple Style A, B or C** and thermocouple **Type J or K**. If not specified, 250 mm (10 in.) thermocouple leads are supplied.

Thermocouple Types

ISA Code	Conductor Characteristics		Temperature Range	
	Positive	Negative	°C	(°F)
J	Iron (Magnetic)	Constantan (Non-magnetic)	-20 to 760	(0 to 1400)
K	Chromel® (Non-magnetic)	Alumel® (Magnetic)	-20 to 1260	(0 to 2300)

For other thermocouple types, contact your Watlow representative.

Cartridge/Insertion Heaters



Metric FIREROD Cartridge Heaters

Mounting Options

Locating Ring

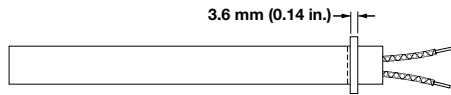

A stainless steel locating ring can be used as a retaining collar to position a FIREROD if mounting requirements are not critical.

For LA, specify the location if the no-heat extension option is requested. On FIRERODs with crimped on leads without the LA option, the locating ring will be located on the last 1/4 in. (6 mm).

To order, specify **locating ring**.

Locating Ring Specifications

Diameter	1/4	3/8	1/2	5/8	3/4
Ring O.D. in. (mm)	1/2 (13)	5/8 (16)	3/4 (19)	7/8 (22)	1 (25)

Flanges

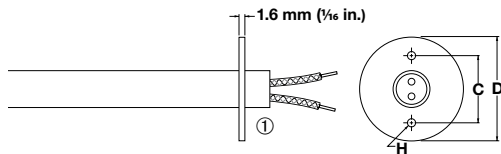

Stainless steel flanges are a convenient mounting method as well as a way to position a heater within an application. These flanges can be located in any no-heat section of the heater sheath. To order, specify **flange**, flange size and location.

Metric FIREROD Diameter mm	Flange Size	D mm (in.)	C mm (in.)	H mm (in.)
6.5, 8, 10, 12.5, 16 ^②	FS	25.4 (1)	19.1 (3/4)	3.7 (9/64)
6.5, 8, 10, 12.5, 16, 20	FM	38.1 (1 1/2)	28.6 (1 1/8)	4.3 (3/16)
16, 20	FL	51.0 (2)	38.1 (1 1/2)	5.3 (13/64)

^① Swaged-in unit pictured.

^② FS flange for 16 mm diameter is without holes.

Threaded Fittings

DIN Thread Size

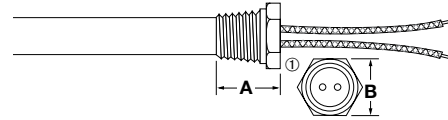

Metric FIREROD Diameter mm	Min. No-Heat Length mm (in.)	Thread Size DIN 13	A mm (in.)	B mm (in.)	Length of Threaded Section
6.5	16 (5/8)	M10 X 1.0	10.0 (3/8)	12 (7/16)	6.0 (1/4)
8.0	16 (5/8)	M12 X 1.0	11.0 (7/16)	14 (1/2)	6.5 (1/4)
10.0	18 (1 1/16)	M14 X 1.5	11.5 (7/16)	17 (5/8)	6.5 (1/4)
12.5	19 (3/4)	M16 X 1.5	12.0 (7/16)	19 (3/4)	6.5 (1/4)
16.0	20 (3/4)	M20 X 1.5	15.0 (3/5)	24 (15/16)	9.0 (3/8)
20.0	22 (7/8)	M26 X 1.5	16.0 (5/8)	30 (1 3/8)	10.0 (3/8)

^① Swaged-in unit pictured.

National Pipe Thread (NPT) Thread Size

Threaded fittings allow for fast, water-tight installation of the heater into a threaded hole. Double threaded fittings are also available. See dimensions noted on the *DIN Thread Size and NPT Thread Size* charts or contact your Watlow representative if application exceeds limitations shown.

To order, specify stainless steel **threaded fittings**.

Metric FIREROD Diameter mm	Min. No-Heat Length mm (in.)	Thread Size NPT (in.)	A mm (in.)	B mm (in.)	Length of Threaded Section
6.5	19 (3/4)	(1/8)	13.5 (1 1/20)	11.0 (7/16)	9.5 (3/8)
8.0	22 (7/8)	(1/4)	17.0 (5/8)	14.0 (1/2)	13.0 (1/2)
10.0	22 (7/8)	(1/4)	17.0 (5/8)	14.0 (1/2)	13.0 (1/2)
12.5	25 (1)	(3/8)	20.0 (7/8)	17.5 (1 1/16)	14.0 (1 1/20)
16.0	28 (1 1/8)	(1/2)	23.0 (9/10)	22.0 (15/16)	16.0 (5/8)
20.0	32 (1 1/4)	(3/4)	26.0 (1)	29.0 (1 1/8)	19.0 (3/4)

Cartridge/Insertion Heaters

**EXTENDED
CAPABILITY**



Extended Capabilities for Metric FIREROD Cartridge Heaters

Termination Options

Post Terminals

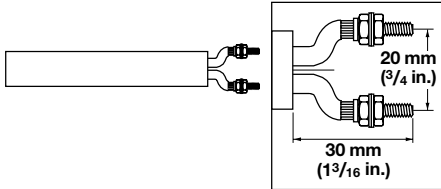

Post terminals provide a quick, secure connection with ring or fork connectors or bus bars. Threaded M4 x 12 mm studs are soldered to the solid power pins. Nuts and washers are provided. This termination is available on 16 and 20 mm (0.63 and 0.79 in.) diameter units. To order, specify **post terminals**.

Options

Individually Controlled Heat Zones

Individually controlled heat zones give the flexibility of controlling temperature by zones, along the length of the metric FIREROD. This is an advantage for heating requirements of certain applications, like seal bars. This internal construction can be ordered on 12.5, 16 and 20 mm diameter units. If not specified, 250 mm crimped on leads will be supplied. To order, specify **individually controlled heat zones** as well as length and wattage per zone and length of crimped on leads.

Epoxy Seal and Leads

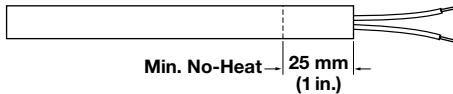

Made-to-order epoxy seal and leads protect the heater against moisture and contamination from lubricating oil, cleaning solvents, plastic material, fumes and organic tapes. This seal is effective up to 302°F (150°C) under continuous operation.

Epoxy seal and leads for made-to-order units greater than 10 in. (250 mm) long comprise a minimum no-heat section of approximately 12 percent of the overall length. Longer no-heat sections are available if required.

Note: Extended Capabilities are subject to a business case review.

Cartridge/Insertion Heaters



MULTICELL™ Heaters

The advanced design of the MULTICELL™ insertion heater from Watlow offers three major advantages: extreme process temperature capability, independent zone control for precise temperature uniformity and loose fit design for easy insertion and removal.

Performance Capabilities

- Engineered to achieve sheath temperatures up to 2050°F (1120°C)
- Up to six independently controllable zones

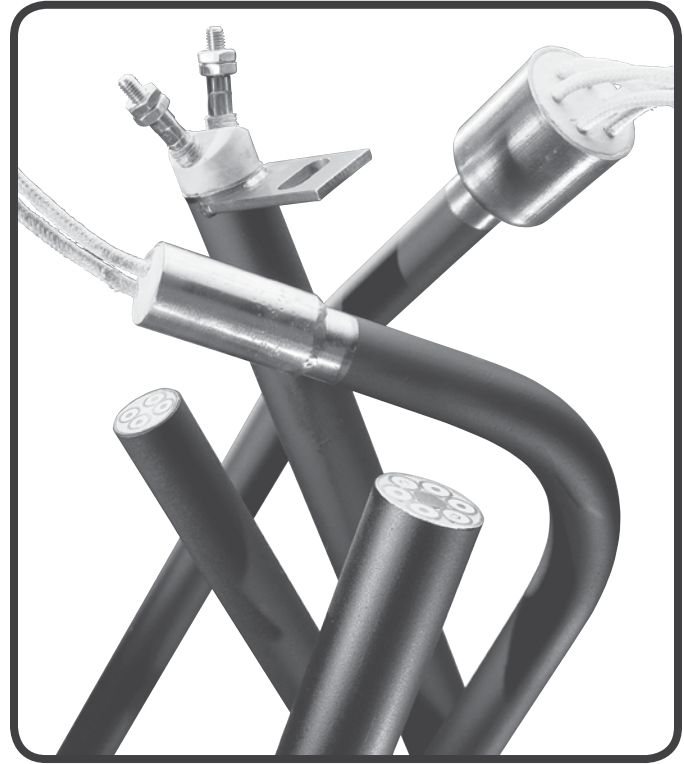
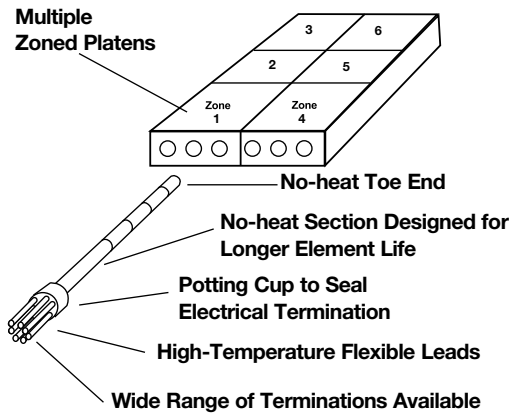

Features and Benefits

Multiple, independently controllable zones

- Allows process temperature uniformity not possible with any other single-sheathed heater

Radiant design of heater

- Allows for loose insertion in boiling holes and piping holes
- Permits easy removal and replacement with minimal down time since it will not bind or seize in the hole

Oxidized sheath

- Provides high emissivity and improves the heater's performance as oxidation increases

Individual metal-sheathed coils swaged into a larger, high-temperature alloy outer sheath

- Provides maximum protection against element burnout through the outer sheath

Independently Controllable Heated Zones

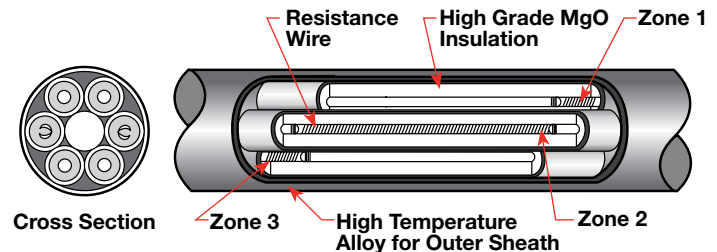

For detailed product and technical data,
see the full MULTICELL product
section located on pages 411 through 416.