

# Compact SCR Power Controller

## EPack Lite Three Phase

HA033173 Issue 3

05/2019



**Eurotherm**<sup>®</sup>

by **Schneider** Electric



## Legal Information

The information provided in this documentation contains general descriptions and/or technical characteristics of the performance of the products contained herein. This documentation is not intended as a substitute for and is not to be used for determining suitability or reliability of these products for specific user applications. It is the duty of any such user or integrator to perform the appropriate and complete risk analysis, evaluation and testing of the products with respect to the relevant specific application or use thereof. Eurotherm Limited, Schneider Electric or any of its affiliates or subsidiaries shall not be responsible or liable for misuse of the information contained herein.

If you have any suggestions for improvements or amendments or have found errors in this publication, please notify us.

You agree not to reproduce, other than for your own personal, non-commercial use, all or part of this document on any medium whatsoever without permission of Eurotherm Limited, given in writing. You also agree not to establish any hypertext links to this document or its content. Eurotherm Limited does not grant any right or license for the personal and non-commercial use of the document or its content, except for a non-exclusive license to consult it on an "as-is" basis, at your own risk. All other rights are reserved.

All pertinent state, regional, and local safety regulations must be observed when installing and using this product. For reasons of safety and to help ensure compliance with documented system data, only the manufacturer should perform repairs to components.

When devices are used for applications with technical safety requirements, the relevant instructions must be followed.

Failure to use Eurotherm Limited software or approved software with our hardware products may result in injury, harm, or improper operating results.

Failure to observe this information can result in injury or equipment damage.

Eurotherm, EurothermSuite, ECAT, EFit, EPack, EPower, Eycon, Eyris, Chessell, Mini8, nanodac, optivis, piccolo and versadac are trademarks of Eurotherm Limited SE, its subsidiaries and affiliated companies. All other trademarks are the property of their respective owners.

© 2019 Eurotherm Limited. All rights reserved.

# Table of Contents

- Table of Contents ..... 4
- Safety Information ..... 8
  - Important Information..... 8
- Safety Notes ..... 9
  - Reasonable use and responsibility ..... 11
  - SELV ..... 12
  - Symbols Used in the Instrument Labeling..... 13
  - Hazardous Substances ..... 13
  - Cybersecurity ..... 14
    - Introduction ..... 14
    - Cybersecurity Good Practices ..... 14
- Introduction ..... 15
  - Unpacking the Units ..... 15
  - Order Code ..... 16
    - Software Upgrade Options..... 18
- Installation ..... 20
  - Mechanical Installation ..... 20
    - Mounting details ..... 20
    - Mechanical installation requirements ..... 22
    - Mounted clearance dimensions ..... 23
      - Bulkhead Mounting ..... 23
      - DIN Rail Mounting..... 26
    - Dimensions ..... 27
      - 16A to 32A unit dimensions ..... 27
      - 40A to 63A unit dimensions ..... 28
      - 80A to 100A unit dimensions ..... 29
      - 125A unit dimensions..... 30
      - Summary - all units (16A - 125A) ..... 31
  - Electrical Installation ..... 32
    - Connection Details ..... 33
    - Auxiliary supply ..... 37
      - 24V ac/dc auxiliary supply ..... 37
      - 85 to 550Vac auxiliary supply ..... 37
    - Connections (Supply Power and Load) ..... 39
      - ..... 42
      - Load Configurations ..... 44
        - Delta ..... 44
        - Star ..... 45
      - Signal wiring..... 47
        - Firing Enable..... 47
        - Alarm Acknowledge ..... 47
        - Main Setpoint..... 47
        - Relay Output..... 47
        - I/O Input & Output Details ..... 49
        - Fuse Holders Contact Data (Fuse Ordering Code HSM)..... 50
- Operator Interface ..... 53
  - Display ..... 53
    - Status area..... 53
    - Softkey icons..... 54
  - Pushbuttons ..... 55
    - Pushbutton functions ..... 55
    - Menu item value selection ..... 55
  - Front Panel Event Indication..... 56

Instrument events .....	56
Indication alarms.....	56
System alarms .....	56
Process alarms .....	56
<b>Quickcode .....</b>	<b>57</b>
Quickcode Menu Parameters Description.....	58
Firing modes definitions .....	59
Logic .....	59
Burst Fixed Firing.....	59
Burst Variable Firing.....	60
Feedback type .....	61
Chop Off Definition.....	61
<b>Configuration from the Front Panel .....</b>	<b>63</b>
Menu Pages .....	64
Meas menu .....	65
Adjust menu .....	66
Examples .....	68
Safety Ramps, Soft Start and Delayed Trigger, firing types.....	68
PLF menu .....	69
Info menu .....	70
Alarms menu.....	71
Alm Disable menu.....	72
Alm Latch Menu .....	73
Alm Stop menu .....	74
Alm Relay menu.....	75
DI Stat menu .....	76
PLF Adjust menu.....	76
Settings menu .....	77
Access menu .....	78
<b>Alarms .....</b>	<b>80</b>
Global System Monitoring .....	80
System Alarms .....	81
Missing mains .....	81
Thyristor short circuit.....	81
Over temperature.....	81
Network dips .....	81
Mains frequency fault detected .....	81
Chop Off alarm.....	81
Process Alarms .....	82
Total Load Failure (TLF) .....	82
Closed Loop alarm.....	82
Alarm input.....	82
Over current detection .....	82
Over Voltage Alarm .....	82
Under Voltage Alarm .....	82
Partial Load Failure (PLF).....	83
Indication Alarms .....	83
Load Over-Current.....	83
<b>Maintenance .....</b>	<b>85</b>
Precautions .....	85
Reasonable use and responsibility .....	85
Preventive Maintenance.....	86
Fusing .....	87
Fuses Holders Contacts Kit .....	89
Fuse holder dimensions.....	90
Auxiliary supply fuse protection .....	93
Instrument upgrade .....	95
Software upgrade.....	95
Obtaining a Passcode via Telephone.....	95

---

EPack Licence Notice .....	96
<b>Technical Specification .....</b>	<b>98</b>
Standards .....	98
Installation Categories .....	99
Specification .....	99
Power (at 45°C) .....	99
Physical .....	101
Environment .....	101
Operator Interface .....	104
Inputs/Outputs .....	104
Digital Inputs .....	105
Relay Specification .....	106
Fuse Holders Contacts Kit Specification .....	106
Mains Network Measurements .....	107



# Safety Information

## Important Information

Read these instructions carefully and look at the equipment to become familiar with the device before trying to install, operate, service, or maintain it. The following special messages may appear throughout this manual or on the equipment to warn of potential hazards or to call attention to information that clarifies or simplifies a procedure.





The addition of either symbol to a “Danger” or “Warning” safety label indicates that an electrical hazard exists which will result in personal injury if the instructions are not followed.



This is the safety alert symbol. It is used to alert you to potential personal injury hazards. Obey all safety messages that follow this symbol to avoid possible injury or death.

 <b>DANGER</b>
<b>DANGER</b> indicates a hazardous situation which, if not avoided, <b>will result in</b> death or serious injury.

 <b>WARNING</b>
<b>WARNING</b> indicates a hazardous situation which, if not avoided, <b>could result in</b> death or serious injury.

 <b>CAUTION</b>
<b>CAUTION</b> indicates a hazardous situation which, if not avoided, <b>could result in</b> minor or moderate injury.

<b>NOTICE</b>
<b>NOTICE</b> is used to address practices not related to physical injury.



## Safety Notes

### DANGER

#### HAZARD OF ELECTRICAL SHOCK, EXPLOSION OR ARC FLASH

- Apply appropriate personal protective equipment (PPE) and follow safe electrical work practices. See applicable national standards e.g. NFPA70E, CSA Z462, BS 7671, NFC 18-510.
- This equipment must only be installed and serviced by qualified electrical personnel.
- Refer to manual for installation and servicing.
- The product is not suitable for isolation applications, within the meaning of EN60947-1. Turn off all power supplying this equipment before working on the loads of the equipment.
- Turn off all power supplying this equipment before working on equipment.
- Always use a properly rated voltage sensing device to confirm power is off.
- If on receipt, the unit or any part within is damaged, do not install but contact your supplier.
- Do not disassemble, repair or modify the equipment. Contact your supplier for repair.
- This product must be installed, connected and used in compliance with prevailing standards and/or installation regulations.
- Do not exceed the device's ratings.
- The unit must be installed in an enclosure or cabinet connected to the protective earth ground.
- Electrically conductive pollution must be excluded from the cabinet in which the product is mounted.
- Do not allow anything to fall through the case apertures and ingress the product.
- Before any other connection is made, the protective earth ground terminal must be connected to a protective conductor.
- Protective conductor must be sized in compliance with local and national regulatory requirements.
- Tighten all connections in conformance with the torque specifications. Periodic inspections are required.
- High speed fuses (supplemental fuses in addition to branch circuit protective device), as listed in fusing sections, are mandatory to protect EPack Lite against load short circuit.
- If opening of either the branch circuit protective device or the high-speed fuses (supplemental fuses) occurs, the product must be examined by suitably qualified personnel and replaced if damaged.
- A High-speed fuse (supplemental fuses in addition to branch circuit protective device) or a double protection fuse as listed in fusing sections is mandatory for 85Vac to 550Vac auxiliary supply.
- If opening of any fuses or branch circuit protection device that supply the 85Vac to 550Vac auxiliary supply occurs, first check the wiring. If the wiring is not damaged, do not replace the fuse and contact the manufacturer's local service center.
- The maximum voltage between any pole of the 85Vac to 550Vac auxiliary supply and all other terminals must be lower than 550Vac.
- The "24V auxiliary supply" is an SELV circuit. The supply Voltage must be derived from a SELV or PELV circuit.
- The I/O Input & Output, the Communications ports are SELV circuit. They must be connected to SELV or PELV circuit.

**Failure to follow these instructions will result in death or serious injury.**

 **DANGER****HAZARD OF ELECTRICAL SHOCK, EXPLOSION OR ARC FLASH**

- The relay output and the fuse holders contacts are compliant to the SELV requirements; they can be connected to SELV, PELV circuit or to voltage up to 230V (maximum value of rated operational voltage to earth:230V)
- Ensure all cables and wiring harness are secured using a relevant strain relief mechanism.
- Respect electrical installation requirements to ensure optimum IP rating.
- Replace doors and plug-in terminals before turning on power to this equipment.
- Use appropriate safety interlocks where personnel and/or equipment hazards exist.

**Failure to follow these instructions will result in death or serious injury.**

 **DANGER****HAZARD OF FIRE**

- Product current rating must be greater than or equal to the maximum current of the load.
- This product does not contain any branch-circuit protection, the installer must add branch-circuit protection upstream of the unit.
- Branch circuit protection must be selected according to maximum current in each phase and must be rated in compliance with local and national regulatory requirements.
- Power connections: The cables must be rated 90°C stranded copper only, the cross section must be selected according to the branch circuit protection rating.
- For 4S load type, the cross-sectional area of the neutral conductor, shall be sized to carry the maximum phase current.
- The cables used to connect the EPack Lite's auxiliary supply and voltage reference must be protected by branch-circuit protection. Such branch-circuit protection must comply with local and national regulatory requirements.
- Connection of two conductors in the same terminal is not permitted, partial or total loss of connection may create an overheat of the terminals.
- The conductor stripping length must be as stated in electrical installation.
- Respect mechanical installation requirements to allow heatsink to dissipate power.
- At commissioning ensure that under maximum load condition, the ambient temperature of the product will not exceed the limit stated in that manual.
- Heat-sink must be cleaned regularly. Periodicity depends on the local environment, but should not exceed 1 year.

**Failure to follow these instructions will result in death or serious injury.**

 **WARNING**
**UNINTENDED EQUIPMENT OPERATION**

- Do not use the product for critical control or protection applications where human or equipment safety relies on the operation of the control circuit.
- Signal and power voltage wiring must be kept separate from one another. Where this is impractical, all wires must be rated to the power voltage & shielded cables are recommended for signal wiring.
- This product has been designed for environment A (Industrial). Use of this product in environment B (domestic, commercial and light industrial) may cause unwanted electromagnetic disturbances in which cases the installer may be required to take adequate mitigation measures.
- For Electromagnetic Compatibility, panel or DIN rail to which product is attached must be grounded.
- Observe all electrostatic discharge precautions before handling the unit.
- Nominal current of product must be set between 25% & 100% of maximum current.
- At commissioning, ensure cybersecurity robustness of the installation.

**Failure to follow these instructions can result in death, serious injury or equipment damage.**

 **CAUTION**
**HOT SURFACE RISK OF BURNS**

- Allow heatsink to cool before servicing.
- Do not allow flammable or heat-sensitive parts in the immediate vicinity of heatsink.

**Failure to follow these instructions can result in injury or equipment damage.**

## Reasonable use and responsibility

The information contained in this manual is subject to change without notice. While every effort has been made to ensure the accuracy of the information, your supplier shall not be held liable for errors contained herein.

EPack Lite is an “AC semiconductor controller for non-motor loads” designed according to IEC60947-4-3 & UL60947-4-1, it meets the requirements of the Low voltage and EMC European Directives which covers safety and EMC aspects.

Use in other applications, or failure to observe the installation instructions of this manual may impair safety or EMC.

The safety and EMC of any system incorporating this product is the responsibility of the assembler/installer of the system.

Failure to use approved software/hardware with our hardware products may result in injury, harm, or improper operating results

Eurotherm shall not be held responsible for any damage, injury, losses or expenses caused by inappropriate use of the product (EPack Lite), or failure to comply with these instructions.

## SELV











SELV is defined (in IEC60947-1) as an electrical circuit in which the voltage cannot exceed 'ELV' under normal conditions or under single fault conditions, including earth ground faults in other circuits. The definition of ELV is complex as it depends on environment, signal frequency, etc. See IEC 61140 for further details.

The I/O connector (5-way) & auxiliary supply (24V ac/dc, 2-way) are compliant to the SELV requirements.

The alarm relay output and the fuse holder contacts are compliant with the SELV requirements; they can be connected to SELV or to voltage up to 230V (Rated insulation voltage  $U_i$ : 230V).

## Symbols Used in the Instrument Labeling

One or more of the symbols below may appear as a part of the instrument labeling.

	Protective conductor terminal		Risk of electric shock
	AC supply only		Precautions against static electrical discharge must be taken when handling this unit.
	Underwriters laboratories listed mark, for Canada and the U.S.		Refer to the manual for instructions
	Do not touch heatsink Hot Surface		CE Mark. Indicates compliance with the appropriate European Directives and Standards
	EAC (EurAsian Conformity) customs union mark of conformity		Regulatory Compliance Mark (RCM) to Australian Communication and Media Authority

## Hazardous Substances

This product conforms to European **R**estriction **o**f **H**azardous **S**ubstances (RoHS) (using exemptions) and **R**egistration, **E**valuation, **A**uthorisation and Restriction of **C**hemicals (REACH) Legislation.

RoHS Exemptions used in this product involve the use of lead. China RoHS legislation does not include exemptions and so lead is declared as present in the China RoHS Declaration.

Californian law requires the following notice:

 **WARNING:** This product can expose you to chemicals including lead and lead compounds which are known to the State of California to cause cancer and birth defects or other reproductive harm. For more information go to:

<http://www.P65Warnings.ca.gov>

# Cybersecurity

## Introduction

When utilizing EPack Lite controllers' range in an industrial environment, it is important to take 'cybersecurity' into consideration: in other words, the installation's design should aim to prevent unauthorized and malicious access. This includes physical access (for instance via the front fascia).

### WARNING

#### UNINTENDED EQUIPMENT OPERATION

- At commissioning, ensure cybersecurity robustness of the installation.

**Failure to follow these instructions can result in death, serious injury or equipment damage.**

To minimize any potential loss of control when communicating across a network via a third-party device (i.e. controller, PLC or configuration tool), ensure all system hardware, software and network design are correctly configured and commissioned for maximum cybersecurity robustness.

## Cybersecurity Good Practices

Overall design of a site network is outside the scope of this manual. The Cybersecurity Good Practices Guide, Part Number HA032968 provides an overview of principles to consider. This is available from [www.eurotherm.co.uk](http://www.eurotherm.co.uk).

## Introduction

This document describes the installation, operation and configuration of a 3 phase EPack Lite Power Controller. The unit includes the following analog and digital inputs and outputs, fitted as standard:

- Two digital inputs (contact closure or voltage level), of which one of the digital inputs can be configured as 10V user output.
- One analog input.
- One change-over relay under software control, configurable by the user.

Chapter [Installation](#) provides details on connector locations and pinouts.

The operator interface consists of a 1.44 inch square TFT display and four pushbuttons for navigation and data selection.

The 3 phase EPack Lite comes in four versions with maximum load currents of: 32A, 63A, 100A and 125A.

The supply voltage for the units can be specified as either low voltage (24V ac/dc) or line voltage (85 to 550V ac). The choice is made at time of order and cannot be changed in the field.

## Unpacking the Units



**DANGER**

**HAZARD OF ELECTRICAL SHOCK, EXPLOSION OR ARC FLASH**

- If on receipt, the unit or any part within is damaged, do not install but contact your supplier.

**Failure to follow these instructions will result in death or serious injury.**

The units are despatched in a special pack, designed to give adequate protection during transit. If any of the outer boxes show signs of damage, open them immediately and examine the instrument. If there is evidence of damage, do not operate the instrument and contact your local representative for instructions.

After the instrument has been removed from its packing, examine the packing to ensure that all accessories and documentation have been removed. Then store the packing for future transport requirements.

## Order Code

EPack Lite power controller is ordered using a short code for hardware and chargeable software options code.



**DANGER**

**HAZARD OF FIRE**

- Product current rating must be greater than or equal to the maximum current of the load.

**Failure to follow these instructions can result in death, serious injury or equipment damage.**

Calculate the maximum current of the load by taking account of load resistive tolerance (tolerance and variation due to temperature) and voltage tolerance.



# Basic Product Coding



Model	
EPACK-LITE-3PH	Power Controller

1 Maximum current	
16A	16 amps
25A	25 amps
32A	32 amps
40A	40 amps
50A	50 amps
63A	63 amps
80A	80 amps
100A	100 amps
125A	125 amps

2 Auxillary Power Supply	
500V	500V max
24V	24V ac/dc

3 Reserved	
XXX	Reserved

4 Control Option	
V2	V <sup>2</sup> control (standard)
I2	I <sup>2</sup> control
OL	Open loop

5 Warranty	
XXX	Standard Warranty
WL005	5 Year Warranty
USWL3	US Extended Warranty

6 Custom Labelling	
XXX	Standard (Eurotherm)
FXXXX	Special Label

7 Fuse	
XXX	Without
HSP	High Speed fuse without microswitch
HSM	High Speed fuse with microswitch

8 Configuration	
XXXXX	Default
LC	Long code

## Optional configuration

9 Nominal load current	
nnnA	1 - Value field 1

10 Nominal line voltage	
100V	100 volts
110V	110 volts
115V	115 volts
120V	120 volts
127V	127 volts
200V	200 volts
208V	208 volts
220V	220 volts
230V	230 volts
240V	240 volts
277V	277 volts
380V	380 volts
400V	400 volts
415V	415 volts
440V	440 volts
460V	460 volts
480V	480 volts
500V	500 volts

11 Load configuration	
3S	Star without neutral
3D	Closed delta
4S	Star with neutral
6D	Open delta

12 Load type	
XX	Resistive
TR	Transformer primary

13 Heater type	
XX	Resistive

14 Firing mode	
PA	Phase Angle
IHC	Intelligent Half Cycle
BF	Variable Modulation Burst Firing
FX	Fix modulation period (default 2 seconds)
LGC	Logic mode

15 Burst min ON time	
XXX	None
FC1	Single cycle 1 period min ON time
C16	Burst with 16 periods min ON time
C64	Burst with 64 periods min ON time

16 Analog Input Function	
XX	None
SP	Setpoint

17 Analog input type	
0V	0-10 volts
1V	1-5 volts
2V	2-10 volts
5V	0-5 volts
0A	0-20 mA
4A	4-20mA

18 Digital Input 1 Function	
XX	None
FI	Firing
LG	Setpoint for logic mode
AK	Alarm acknowledgement
FB	Fuse Blown

19 Digital Input 2 Function	
XX	None
FI	Firing
LG	Setpoint for logic mode
AK	Alarm acknowledgement
FB	Fuse Blown
SU	10V supply

20 Reserved	
XXX	Reserved

## Software Upgrade Options



1	Serial number instrument
nnnn	Serial number

2	Current ratings upgrade
XXX	No change
16A-25A	16A to 25A
16A-32A	16A to 32A
25A-32A	25A to 32A
40A-50A	40A to 50A
40A-63A	40A to 63A
50A-63A	50A to 63A
80A-100A	80A to 100A



# Installation

## Mechanical Installation

### Mounting details

#### **DANGER**

##### **HAZARD OF ELECTRICAL SHOCK, EXPLOSION OR ARC FLASH**

- Apply appropriate personal protective equipment (PPE) and follow safe electrical work practices. See applicable national standards e.g. NFPA70E, CSA Z462, BS 7671, NFC 18-510.
- This equipment must only be installed and serviced by qualified electrical personnel.
- Turn off all power supplying this equipment before working on equipment.
- Always use a properly rated voltage sensing device to confirm power is off.
- If on receipt, the unit or any part within is damaged, do not install but contact your supplier.
- Do not disassemble, repair or modify the equipment. Contact your supplier for repair.
- This product must be installed, connected and used in compliance with prevailing standards and/or installation regulations.
- Do not exceed the device's ratings.

**Failure to follow these instructions will result in death or serious injury.**

#### **DANGER**

##### **HAZARD OF ELECTRICAL SHOCK, EXPLOSION OR ARC FLASH**

- The unit must be installed in an enclosure or cabinet connected to the protective earth ground.

**Failure to follow these instructions will result in death or serious injury.**

#### **Notes:**

1. CE: protective earth ground minimum size must be selected according to IEC 60364-5-54 table 54.2 or IEC61439-1 table 5 or applicable national standards.
2. U.L.: protective earth ground minimum size must be selected according to NEC table 250.122 or NFPA79 table 8.2.2.3 or applicable national standards.

 **DANGER****HAZARD OF ELECTRICAL SHOCK, EXPLOSION OR ARC FLASH**

- Electrically conductive pollution must be excluded from the cabinet in which the product is mounted.

**Failure to follow these instructions will result in death or serious injury.**

**Notes:**

1. The product has been designed for pollution degree 2 according to IEC60947-1 definition: Normally, only non-conductive pollution occurs. Occasionally, however, a temporary conductivity caused by condensation may be expected.
2. Electrically conductive pollution must be excluded from the cabinet in which the product is mounted. To ensure a suitable atmosphere in conditions of conductive pollution, fit adequate air conditioning/filtering/cooling equipment to the air intake of the cabinet, e.g. fitting fan-cooled cabinets with a fan failure detection device or a thermal safety cut-out.

 **DANGER****HAZARD OF ELECTRICAL SHOCK, EXPLOSION OR ARC FLASH**

- Do not allow anything to fall through the case apertures and ingress the product.

**Failure to follow these instructions will result in death or serious injury.**

**Note:** Conductive or non-conductive parts which ingress the product may reduce or short circuit the insulation barriers inside the product.

 **WARNING****UNINTENDED EQUIPMENT OPERATION**

- Observe all electrostatic discharge precautions before handling the unit.

**Failure to follow these instructions can result in death, serious injury or equipment damage.**

## Mechanical installation requirements

 **DANGER**

**HAZARD OF FIRE**

- Respect mechanical installation requirements to allow heatsink to dissipate power.

**Failure to follow these instructions can result in death or serious injury.**

**Notes:**

1. The product is designed to be mounted vertically.
2. There must be no obstructions (above or below) which could reduce or hamper airflow.
3. If more than one instance of the product is in the same cabinet, they must be mounted in such a way that air from one unit is not drawn into another.
4. The gap between two EPack Lite devices must be at minimum 10mm.
5. The gap between EPack Lite and cable tray must be at least those defined in the table in Mounted clearance dimensions.

 **DANGER**

**HAZARD OF FIRE**

- At commissioning ensure that under maximum load condition, the ambient temperature of the product will not exceed the limit stated in that manual.

**Failure to follow these instructions can result in death or serious injury.**

**Notes:**

1. EPack Lite has been designed for a maximum temperature of 45°C (113°F) at 1000m (3281ft) altitude at nominal current & 40°C (104°F) at 2000m (6562ft) altitude at nominal current.
2. At commissioning ensure that the ambient temperature inside the cabinet does not exceed the limit under maximum load condition.

 **DANGER**

**HAZARD OF FIRE**

- Heat-sink must be cleaned regularly. Periodicity depends on the local environment, but should not exceed 1 year.

**Failure to follow these instructions can result in death or serious injury.**

 **CAUTION**

**HOT SURFACE RISK OF BURNS**

- Do not allow flammable or heat-sensitive parts in the immediate vicinity of heatsink.

**Failure to follow these instructions can result in injury or equipment damage.**

## Mounted clearance dimensions

Phase:	3 phase			
Amps:	16 - 32A	40 - 63A	80 - 100A	125A
EPack Lite clearance dimensions mm (inches):				
between cable tray and EPack Lite	70 (2.76)	100 (3.94)	150 (5.91)	150 (5.91)
between two cable trays	306 (12.05)	366 (14.41)	530 (20.87)	530 (20.87)
between or side by side another EPack Lite	10 (.39)	10 (.39)	10 (.39)	10 (.39)

Figures 4 to 7 show dimensions for the various units.

The units are designed for DIN Rail or bulkhead mounting using the mounting fixings supplied.

## Bulkhead Mounting

### 32A and 63A Units

For Bulkhead mounting, fit the upper bracket 'A' to the rear of the unit by removing screw 'B' x2 and associated shakeproof washers, offering the bracket up to the unit, and then securing it by installing x2 screw 'B' ensuring that the bracket is correctly oriented (as shown) and that the shakeproof washers are fitted between the screw head and the bracket.

Use a screwdriver with a 3mm AF hexagonal bit. The recommended tightening torque is 1.5 Nm (1.1 lb-ft). To mount, secure using x2 M5 screws and shakeproof washers using the top and bottom mount points.

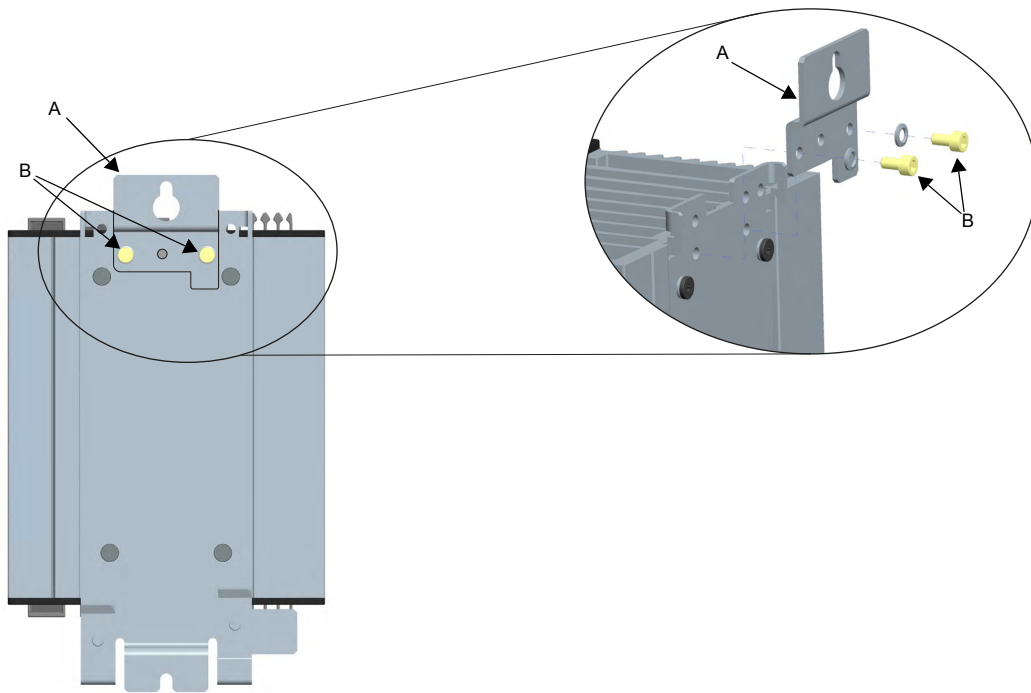

Figure 1 Fitting upper bulkhead mounting bracket (32A unit shown; 63A units similar)



### 80A, 100A and 125A Units

For bulkhead mounting, brackets 'A' and 'B' on the rear of the unit are used to mount the product. Secure using x3 M6 screws and shakeproof washers using the top and bottom mount points.

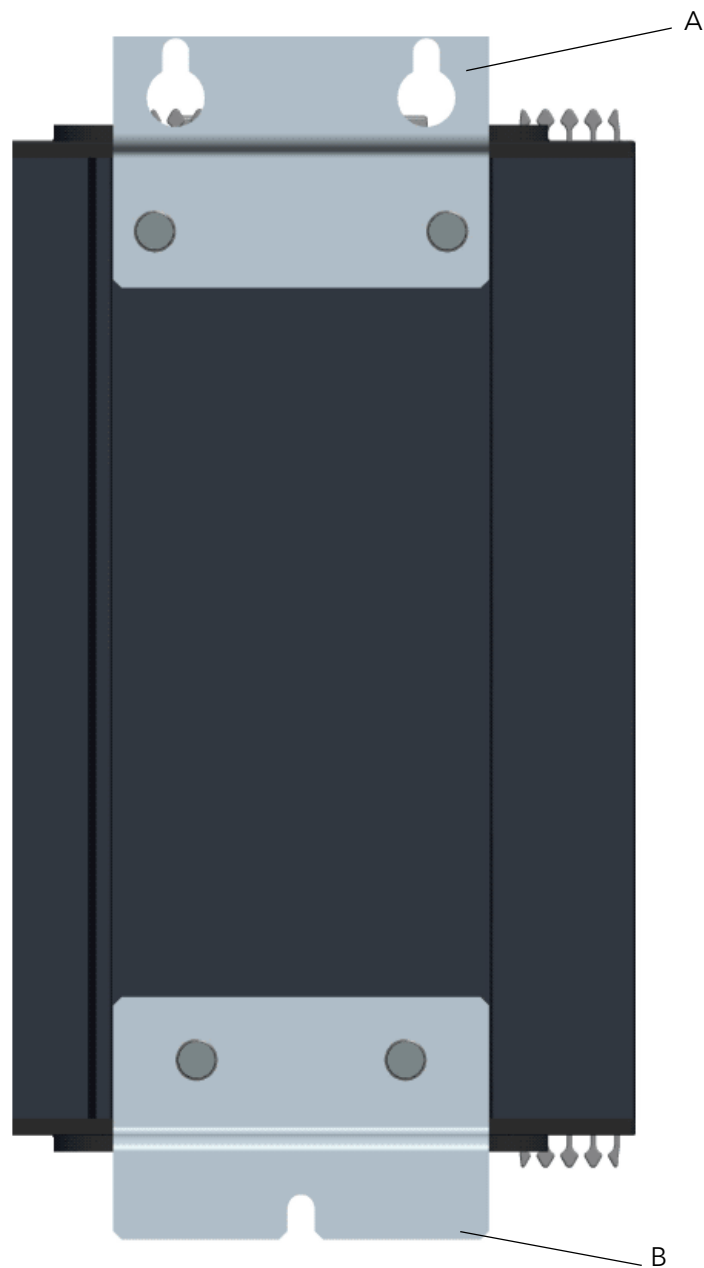

Figure 2 Bulkhead mounting 80A/100A unit shown (125A similar)

## DIN Rail Mounting

### 32A and 63A Units

The 32A and 63A units can be mounted using two horizontal, parallel, 7.5mm or 15mm DIN rails. Locate the upper mounting hooks 'A' (x2) on the upper DIN rail 'B'. To secure the unit against the lower DIN rail 'C', slide the lower mounting catches 'D' (x2) upwards and tighten the mounting screws 'E' (x2) to the recommended tightening torque of 3Nm (2.2lb ft).

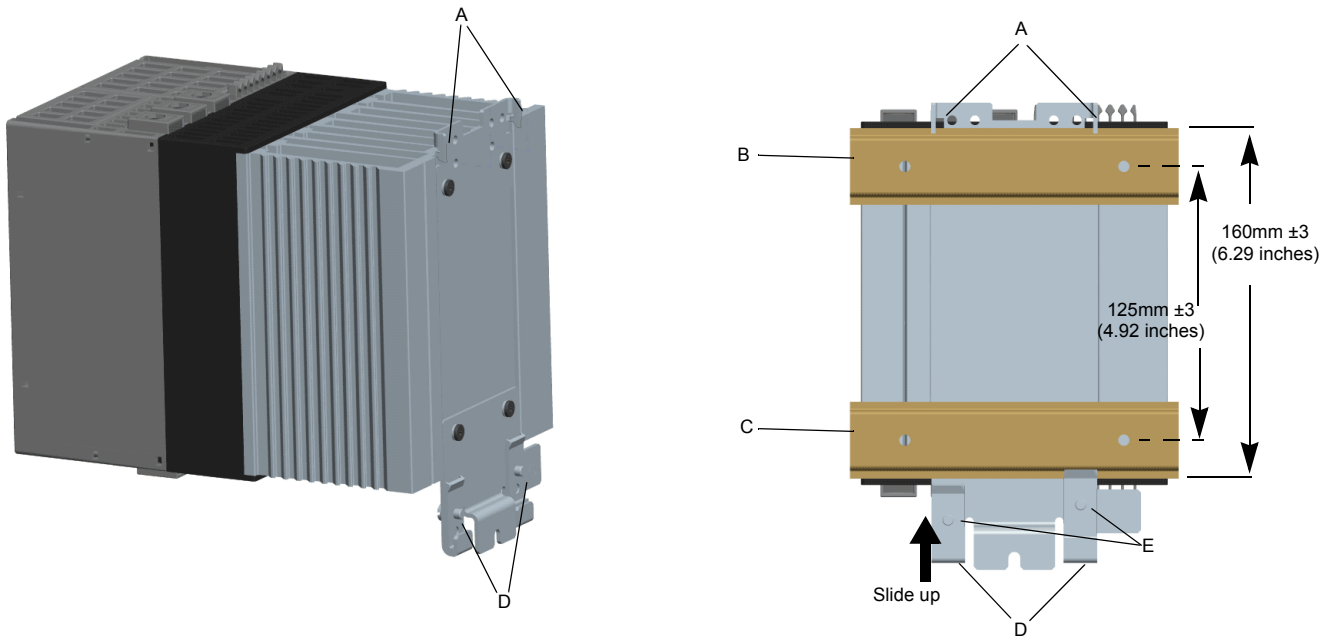

Figure 3 DIN rail mounting (32A unit shown; 63A units similar)

### 80A, 100A and 125A Units

The higher power units cannot be mounted using any type of DIN rail configuration due to the size and relative mass.

See "Bulkhead Mounting" on page 23 for further details.

# Dimensions

## 16A to 32A unit dimensions

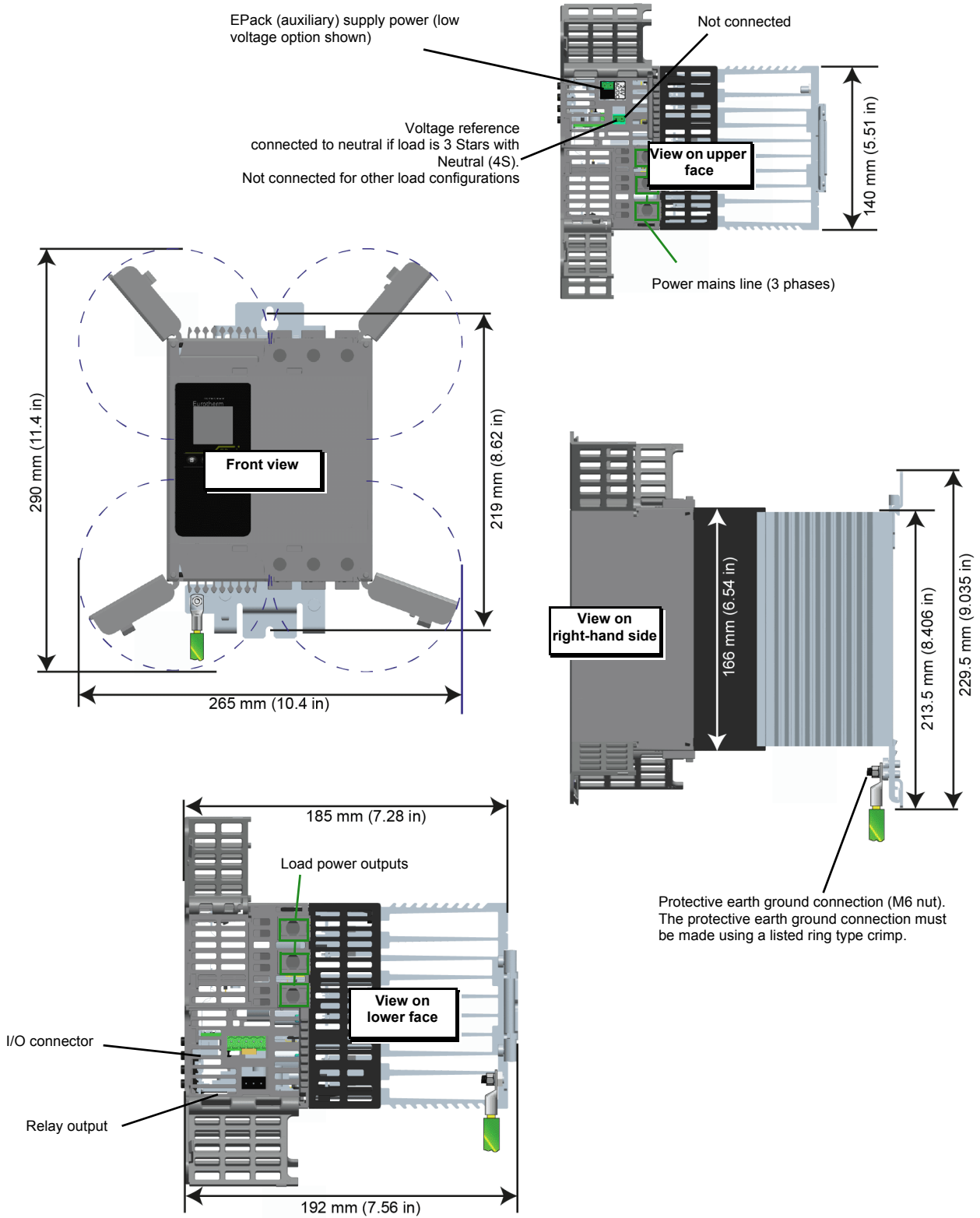

Figure 4 Mechanical installation details (16A to 32A units)

### 40A to 63A unit dimensions

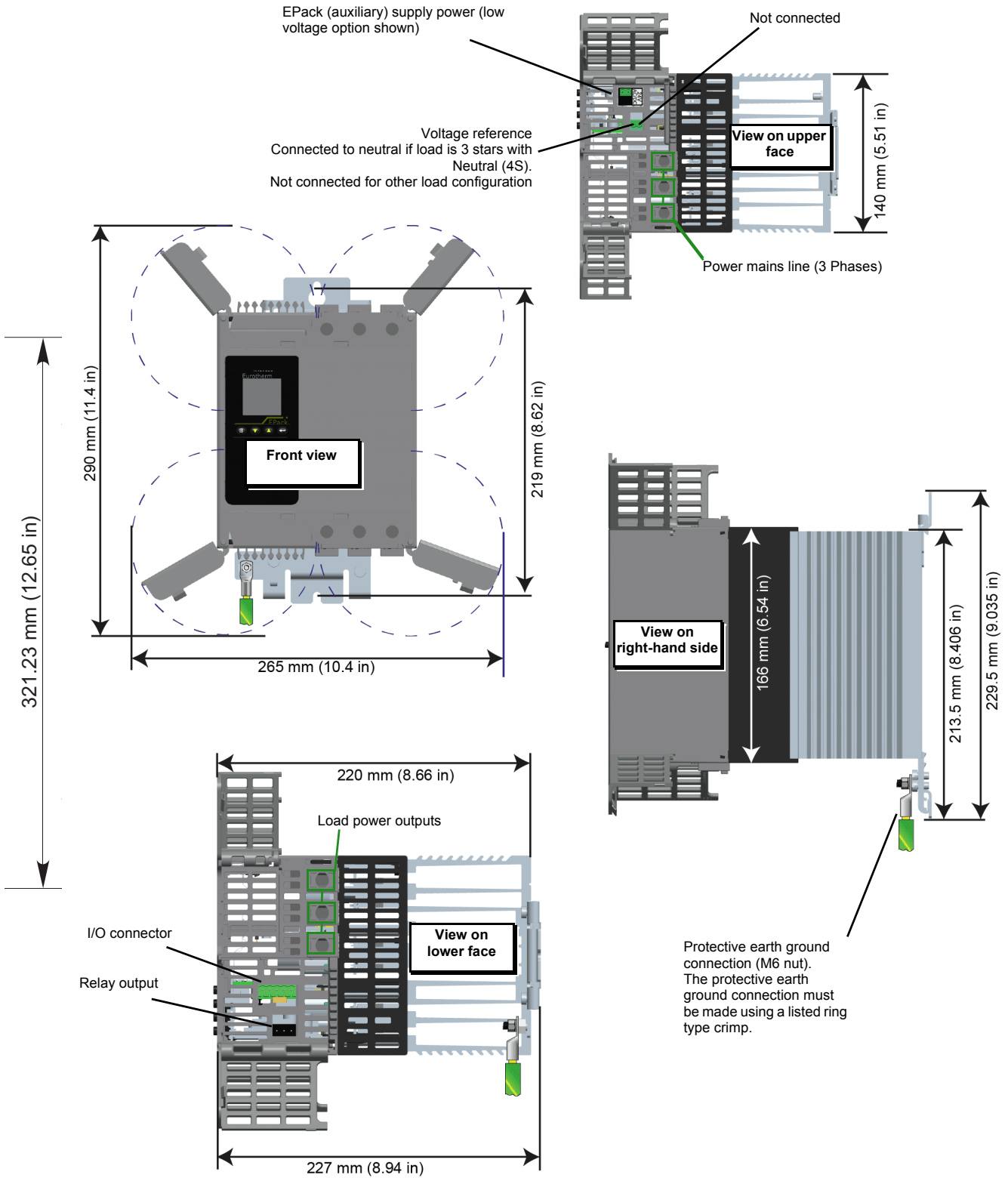

Figure 5 Mechanical installation details (40A to 63A units)

### 80A to 100A unit dimensions

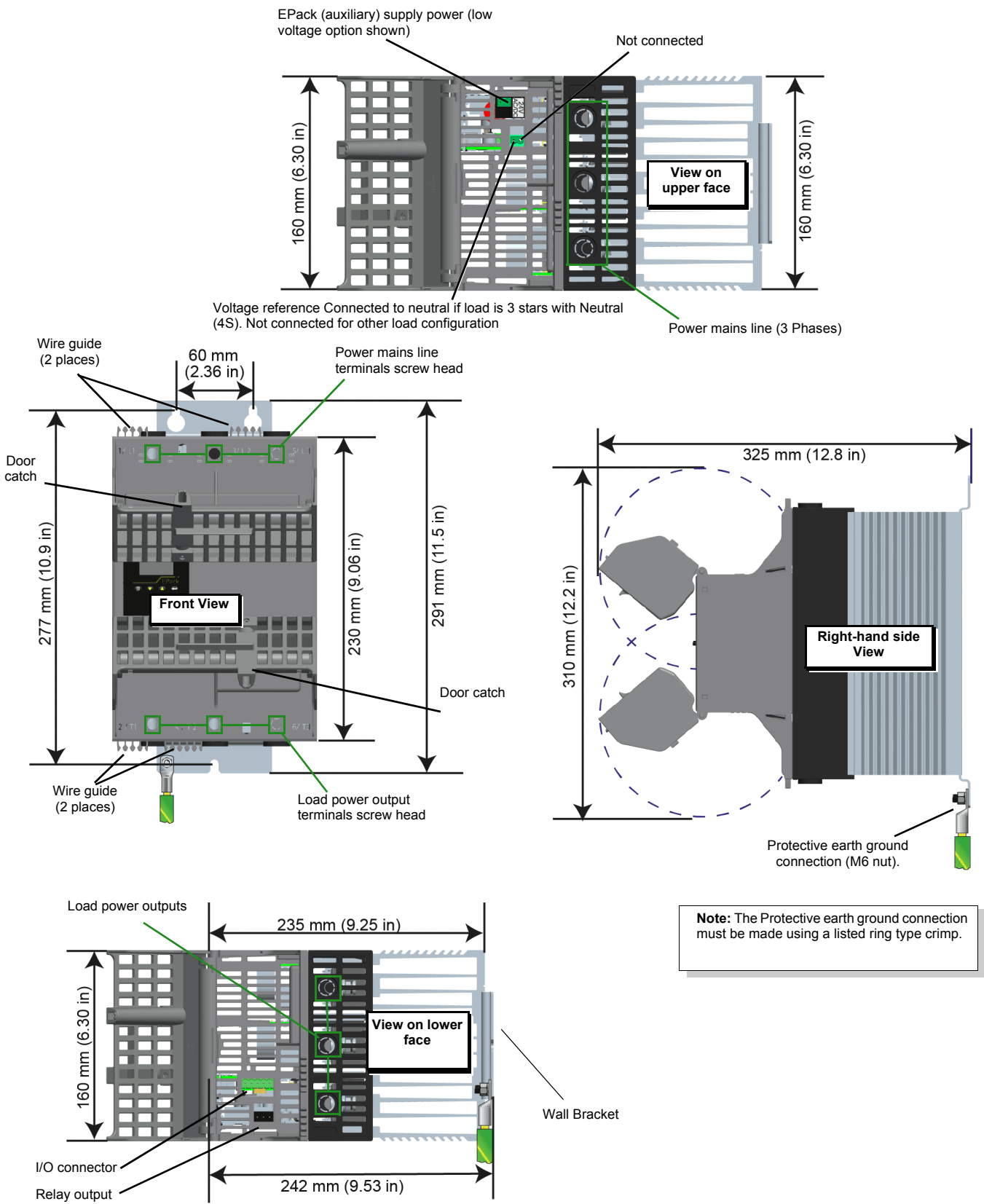

Figure 6 Mechanical installation details (80A to 100A units) (doors open).

### 125A unit dimensions

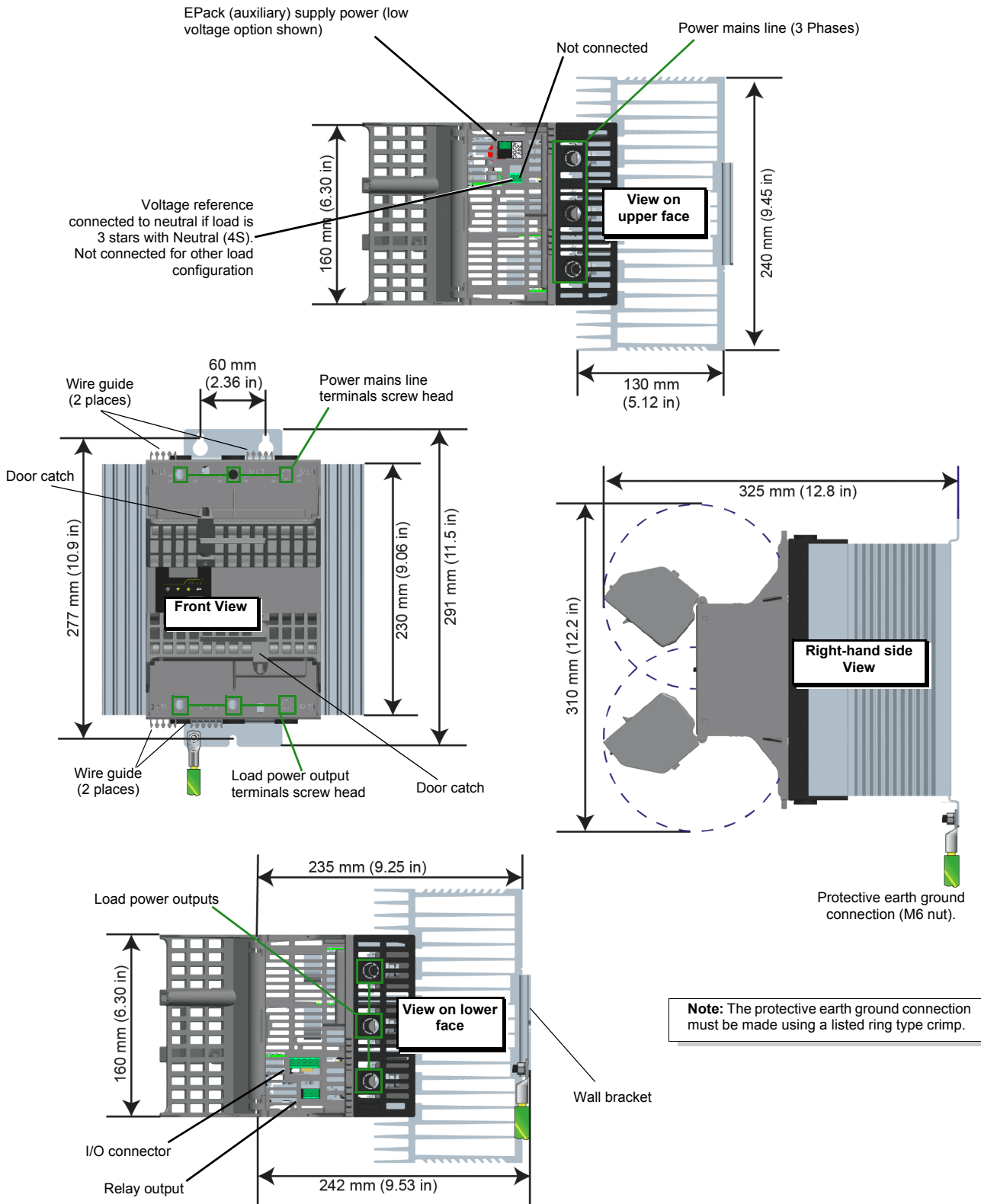



Figure 7 Mechanical installation details (125A units) (Doors open).

## Summary - all units (16A - 125A)

Phase	3 phase			
Amps:	16 - 32A	40 - 63A	80 - 100A	125A
Dimensions mm (inches)				
<b>Height</b>	166 (6.535)	166 (6.535)	230 (9.055)	230 (9.055)
with Double DIN Rail	213.5 (8.405)	213.5 (8.405)	N/A <sup>1</sup>	N/A <sup>1</sup>
with Wall back plate	229.5 (9.035)	229.5 (9.035)	291 (11.456)	291 (11.456)
Doors open	290 (11.417)	290 (11.417)	310 (12.204)	310 (12.204)
<b>Depth</b>	185 (7.283)	220 (8.661)	235 (9.251)	235 (9.251)
with Wall back plate	192 (7.559)	227 (8.937)	242 (9.527)	242 (9.527)
with doors open	N/A <sup>2</sup>	N/A <sup>2</sup>	325 (12.795)	325 (12.795)
<b>Width</b>	140 (5.511)	140 (5.511)	160 (6.299)	240 (9.448)
with doors open	242 (9.527)	242 (9.527)	N/A <sup>3</sup>	N/A <sup>3</sup>
<b>Wall mount fixings</b>				
Distance apart:				
Medium mount	219 (8.622)	219 (8.622)	-	-
Large mount	-	-	277 (10.905)	277 (10.905)
Double DIN Rails	125 ±3 (4.921 ±0.12)	125 ±3 (4.921 ±0.12)	-	-
Distance between top, two mounting fixings:				
Large mount	-	-	60 (2.362)	60 (2.362)
<b>HeatSink Depth</b>	55 (2.165)	90 (3.543)	97 (3.818)	130 (5.118)

1. Not applicable, double DIN rail option not available.
2. Not applicable, doors open sideways increasing only the width.
3. Not applicable, doors open vertically (up or down) towards the center of the product increasing only the depth.

## Electrical Installation

 **DANGER**

**HAZARD OF ELECTRICAL SHOCK, EXPLOSION OR ARC FLASH**

- Apply appropriate personal protective equipment (PPE) and follow safe electrical work practices. See applicable national standards e.g. NFPA70E, CSA Z462, BS 7671, NFC 18-510.
- This equipment must only be installed and serviced by qualified electrical personnel.
- Turn off all power supplying this equipment before working on equipment.
- Always use a properly rated voltage sensing device to confirm power is off.
- If on receipt, the unit or any part within is damaged, do not install but contact your supplier.
- Do not disassemble, repair or modify the equipment. Contact your supplier for repair.
- This product must be installed, connected and used in compliance with prevailing standards and/or installation regulations.
- Do not exceed the device's ratings.

**Failure to follow these instructions will result in death or serious injury.**

 **DANGER**

**HAZARD OF ELECTRICAL SHOCK, EXPLOSION OR ARC FLASH**

- Do not allow anything to fall through the case apertures and ingress the product.

**Failure to follow these instructions will result in death or serious injury.**

**Note:** Conductive or non-conductive parts which ingress product may reduce or short the insulations barriers inside the product.

 **DANGER**

**HAZARD OF ELECTRICAL SHOCK, EXPLOSION OR ARC FLASH**

- Ensure all cables and wiring harness are secured using a relevant strain relief mechanism.

**Failure to follow these instructions will result in death or serious injury.**

**Note:** Wires may slip out of the terminals.



 **WARNING**
**UNINTENDED EQUIPMENT OPERATION**

- Observe all electrostatic discharge precautions before handling the unit.
- Signal and power voltage wiring must be kept separate from one another. Where this is impractical, all wires must be rated to the power voltage & shielded cables are recommended for signal wiring.
- For Electromagnetic Compatibility, panel or DIN rail to which product is attached must be grounded.

**Failure to follow these instructions can result in death, serious injury or equipment damage.**

## Connection Details

 **DANGER**
**HAZARD OF ELECTRICAL SHOCK, EXPLOSION OR ARC FLASH**

- Before any other connection is made, the protective earth ground terminal must be connected to a protective conductor.
- Protective conductor must be sized in compliance with local and national regulatory requirements.

**Failure to follow these instructions will result in death or serious injury.**

The earth connection must be made by using a lug terminal of size as given in Table 1, "Connection Details". The cables must be rated 90°C stranded copper only.

- CE: The protective earth ground cable minimum size must be selected according to IEC 60364-5-54 table 54.2 or IEC61439-1 table 5 or applicable national standards. The protective earth ground connection must be made to the unit with a ring type crimp terminal, using the nut and shakeproof washer supplied (M6 for 16A to 125A units).
- U.L.: The protective earth ground cable cross sectional area should be selected according to NEC table 250.122 or NFPA79 table 8.2.2.3 or applicable national standards. The protective earth ground connection must be made to the unit with a U.L. listed ring type crimp terminal, using the nut and shakeproof washer supplied (M6 for 16A to 125A units).

 **DANGER****HAZARD OF FIRE**

- Power connections: The cables must be rated 90°C stranded copper only, the cross section must be selected according to the branch circuit protection rating.

**Failure to follow these instructions will result in death or serious injury.**

CE: Wire conductor cross sections must comply with IEC 60364-5-52 or applicable national standards

U.L.: Wire conductor cross sections must comply with NEC Table 310.15(B)(16) (formerly Table 310.16) taking account of table 310.15(B)(2) for the ampacity correction factors or NFPA79 Table 12.5.1 taking account of Table 12.5.5(a) for the ampacity correction factors or applicable national standards.

Table 1, "Connection Details" gives details of tightening torques for the various supply power and signal wiring connections.

Table 1: Connection Details

Terminals	Product Rating	Terminal Capacity <sup>1</sup>		Wire Type	Torque	Comments
		mm <sup>2</sup>	AWG			
Supply voltage (1/L1, 3/L2, 5/L3) and Load supply (2/T1, 4/T2, 6/T3)	16A to 63A	1.5mm <sup>2</sup> to 25mm <sup>2</sup>	AWG 14 to AWG 4	Stranded copper Rated 90°C (194°F)	2Nm (18lb in)	PZ2 or Flat-bladed screwdriver 5.5 x 1.0mm (7/32in x 0.039in) or 6.5 x 1.2mm (1/4in x 0.047in)
	80A to 125A	10mm <sup>2</sup> to 50mm <sup>2</sup>	AWG 8 to AWG 2/0		5.6Nm (50lb in)	Flat-bladed screwdriver 5.5 x 1mm (7/32in x 0.039in) or 6.5 x 1.2mm (1/4in x 0.047in)
Protective earth ground	16A to 63A	M6 ring-type crimp terminal			2.5Nm (22lb in)	U.L.: Listed ring-type crimp terminal must be used
	80A to 125A	M6 ring-type crimp terminal			5.6Nm (50lb in)	U.L.: Listed ring-type crimp terminal must be used
Voltage Reference (Vref) (2-way) Supply (24Vac/dc) (2-way) Supply (85V-550Vac)(3-way) I/O connector (5-way) Relay connector (3-way)	All	0.25mm <sup>2</sup> to 2.5mm <sup>2</sup>	AWG 24 to AWG 12	Stranded copper Rated 75°C (167°F)	0.56Nm (5lb in)	Flat-bladed screwdriver 3.5 x 0.6mm (1/8in x 0.0236in)

1. AWG (American Wire Gauge) for USA and Canada (according to cUL standard); section in mm<sup>2</sup> for IEC countries (according to IEC/EN standard).

 **DANGER****HAZARD OF ELECTRICAL SHOCK, EXPLOSION OR ARC FLASH**

- Tighten all connections in conformance with the torque specifications. Periodic inspections are required.

**Failure to follow these instructions will result in death or serious injury.**

See Table 1, "Connection Details".

Wires are not properly retained in terminals with insufficient torque.

Insufficient torque may increase the contact resistance:

- The protective earth ground connection may be too resistive. In case of short circuit between live parts and heatsink, the heatsink may reach a dangerous voltage.
- The power terminals will overheat.

Excessive torque may damage the terminal.

 **DANGER****HAZARD OF FIRE**

- Connection of two conductors in the same terminal is not permitted.

**Failure to follow these instructions will result in death or serious injury.**

Partial or total loss of connection as a result of attempting to connect two or more conductors in the same terminal results in an overheat of the terminals.

See Table 1, "Connection Details".

## Auxiliary supply

The auxiliary supply connections (to operate the EPack unit) are terminated using a 2-way (24V ac/dc version) or 3-way (85 to 550Vac version) connector, located on the upper side of the unit, as shown in [Figure 8](#) and [Figure 9](#).

### 24V ac/dc auxiliary supply

 <b>DANGER</b>
<p><b>HAZARD OF FIRE</b></p> <ul style="list-style-type: none"> <li>The cables used to connect the EPack Lite’s auxiliary supply and voltage reference must be protected by branch-circuit protection. Such branch-circuit protection must comply with local and national regulatory requirements.</li> </ul> <p><b>Failure to follow these instructions will result in death or serious injury.</b></p>

- CE: branch-circuit protection must be selected according to IEC 60364-4-43 or applicable local regulations.
- UL: branch-circuit protection must be selected according to NEC article 210.20, it is necessary for compliance with National Electric Code(NEC) requirements.

 <b>DANGER</b>
<p><b>HAZARD OF ELECTRICAL SHOCK, EXPLOSION OR ARC FLASH</b></p> <ul style="list-style-type: none"> <li>The “24V auxiliary supply” is an SELV circuit. The supply Voltage must be derived from a SELV or PELV circuit.</li> </ul> <p><b>Failure to follow these instructions will result in death or serious injury.</b></p>

SELV is defined (in IEC60947-1) as an electrical circuit in which the voltage cannot exceed 'ELV' under normal conditions or under single fault conditions, including earth ground faults in other circuits.

The definition of ELV is complex as it depends on environment, signal frequency, etc. See IEC 61140 for further details.

### 85 to 550Vac auxiliary supply

 <b>DANGER</b>
<p><b>HAZARD OF FIRE</b></p> <ul style="list-style-type: none"> <li>The cables used to connect the EPack Lite’s auxiliary supply and voltage reference must be protected by branch-circuit protection. Such branch-circuit protection must comply with local and national regulatory requirements.</li> </ul> <p><b>Failure to follow these instructions will result in death or serious injury.</b></p>

Branch circuit protection is mandatory to protect the cable used to connect the auxiliary supply.

- CE: branch-circuit protection must be selected according to IEC 60364-4-43 or applicable local regulations.
- UL: branch-circuit protection must be selected according to NEC article 210.20, it is necessary for compliance with National Electric Code(NEC) requirements.

 **DANGER**

**HAZARD OF ELECTRICAL SHOCK, EXPLOSION OR ARC FLASH**

- A High-speed fuse (supplemental fuses in addition to branch circuit protective device) or a double protection fuse as listed in "Fusing" on page 87 is mandatory for 85Vac to 550Vac auxiliary supply.

**Failure to follow these instructions will result in death or serious injury.**

This fuse is necessary to avoid the 85Vac to 550Vac auxiliary supply to emit flame or molten element in case of breakdown of a component.

High-speed fuse (supplemental fuse) does not protect the wiring, they must be fitted **(in addition to branch circuit protective device)**.

Double protection fuse comprises a branch circuit fuse and a high-speed fuse.

Double protection fuses must be selected according to applicable national standards

Branch circuit protection fuses standards in USA/Canada differ from IEC standards (e.g; Europe (CE)). Therefore:

- A fuse approved as branch circuit protection fuses in USA/Canada is not a branch circuit in all countries where IEC standards apply (e.g; Europe (CE)).
- A fuse approved as branch circuit protection fuses in all countries where IEC standards apply (e.g; Europe (CE)) is not a branch circuit in USA/Canada.

See tables in "Fusing" on page 87.

 **DANGER**

**HAZARD OF ELECTRICAL SHOCK, EXPLOSION OR ARC FLASH**

- If opening of any fuses or branch circuit protection device that supply the 85Vac to 550Vac auxiliary supply occurs, first check the wiring. If the wiring is not damaged, do not replace the fuse and contact the manufacturer's local service center.

**Failure to follow these instructions will result in death or serious injury.**

If the wiring is not damaged a component inside the 85Vac to 550Vac auxiliary supply is broken and product must go back to service center.

 **DANGER**

**HAZARD OF ELECTRICAL SHOCK, EXPLOSION OR ARC FLASH**

- The maximum voltage between any pole of the 85Vac to 550Vac auxiliary supply and all other terminals must be lower than 550Vac.

**Failure to follow these instructions will result in death or serious injury.**

If the 85Vac to 550Vac auxiliary supply is supplied by a dedicated transformer the phasing must be checked to avoid overvoltage.

## Connections (Supply Power and Load)

 **DANGER**

**HAZARD OF FIRE**

- This product does not contain any branch-circuit protection, therefore the installer must add branch-circuit protection upstream of the unit.
- Branch circuit protection must be selected according to maximum current in each phase and must be rated in compliance with local and national regulatory requirements.

**Failure to follow these instructions will result in death or serious injury.**

Branch circuit protection is mandatory to protect the wiring.

- CE: branch-circuit protection must be selected according to IEC 60364-4-43 or applicable local regulations.
- UL: branch-circuit protection must be selected according to NEC article 210.20, it is necessary for compliance with National Electric Code(NEC) requirements.

 **DANGER**

**HAZARD OF FIRE**

- Power connections: The cables must be rated 90°C stranded copper only, the cross section must be selected according to the branch circuit protection rating.

**Failure to follow these instructions will result in death or serious injury.**

CE: Wire conductor cross sections must comply with IEC 60364-5-52 or applicable national standards

U.L.: Wire conductor cross sections must comply with NEC Table 310.15(B)(16) (formerly Table 310.16) taking account of table 310.15(B)(2) for the ampacity correction factors or NFPA79 Table 12.5.1 taking account of Table 12.5.5(a) for the ampacity correction factors or applicable national standards.

 **DANGER**

**HAZARD OF FIRE**

- For 4S load type, the cross-sectional area of the neutral conductor, must be sized to carry the maximum phase current.

**Failure to follow these instructions will result in death or serious injury.**

Calculate the maximum current of the load by taking account of load resistive tolerance (tolerance and variation due to temperature) and voltage tolerance.

 **DANGER****HAZARD OF ELECTRICAL SHOCK, EXPLOSION OR ARC FLASH**

- High speed fuses (supplemental fuses in addition to branch circuit protective device), as listed in fusing sections, are mandatory to protect EPack Lite against load short circuit.
- If opening of either the branch circuit protective device or the high-speed fuses (supplemental fuses) occurs, the product must be examined by suitably qualified personnel and replaced if damaged.

**Failure to follow these instructions will result in death or serious injury.**

See tables in "Fusing" on page 87.



 **DANGER****HAZARD OF ELECTRICAL SHOCK, EXPLOSION OR ARC FLASH**

- Respect electrical installation requirements to ensure optimum IP rating.

**Failure to follow these instructions will result in death or serious injury.**

Products are rated IP20 according to EN60529.

If the conductor stripping lengths of the power cables are longer than the requirements, then IP20 is compromised.

If the conductor stripping lengths of the power cables are shorter than the requirements there is a potential risk of total loss of connection. Wires may slip out of the terminals.

If the breakaway features are removed for cables with diameter lower than 9mm then IP20 rating is compromised and the product is rated at IP10.

 **DANGER****HAZARD OF FIRE**

- The conductor stripping length must be as stated in Electrical Installation.

**Failure to follow these instructions will result in death or serious injury.**

If the conductor stripping lengths of the power cables are shorter than the requirements there is a potential risk of partial loss of connection which may create an overheat of the terminals

 **DANGER****HAZARD OF ELECTRICAL SHOCK, EXPLOSION OR ARC FLASH**

- Replace doors and plug-in terminals before turning on power to this equipment

**Failure to follow these instructions will result in death or serious injury.**

If the upper and/or lower access door are open, then IP20 rating is compromised and the products are rated at IP10.

### 16A to 32A and 40A to 63A Units

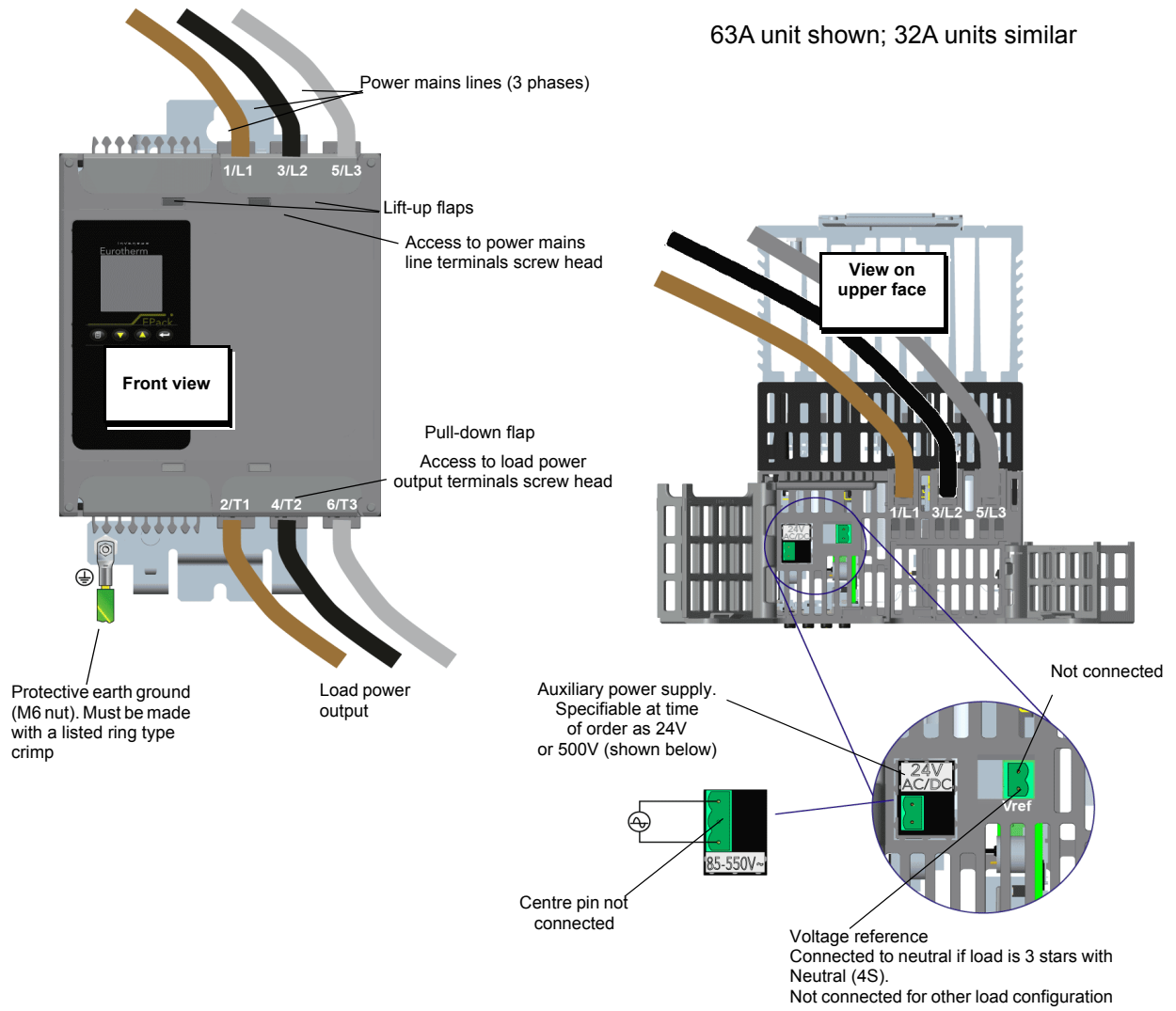

Figure 8 Supply power and Load connection details (16A to 63A units)

## 80A, 100A and 125A units

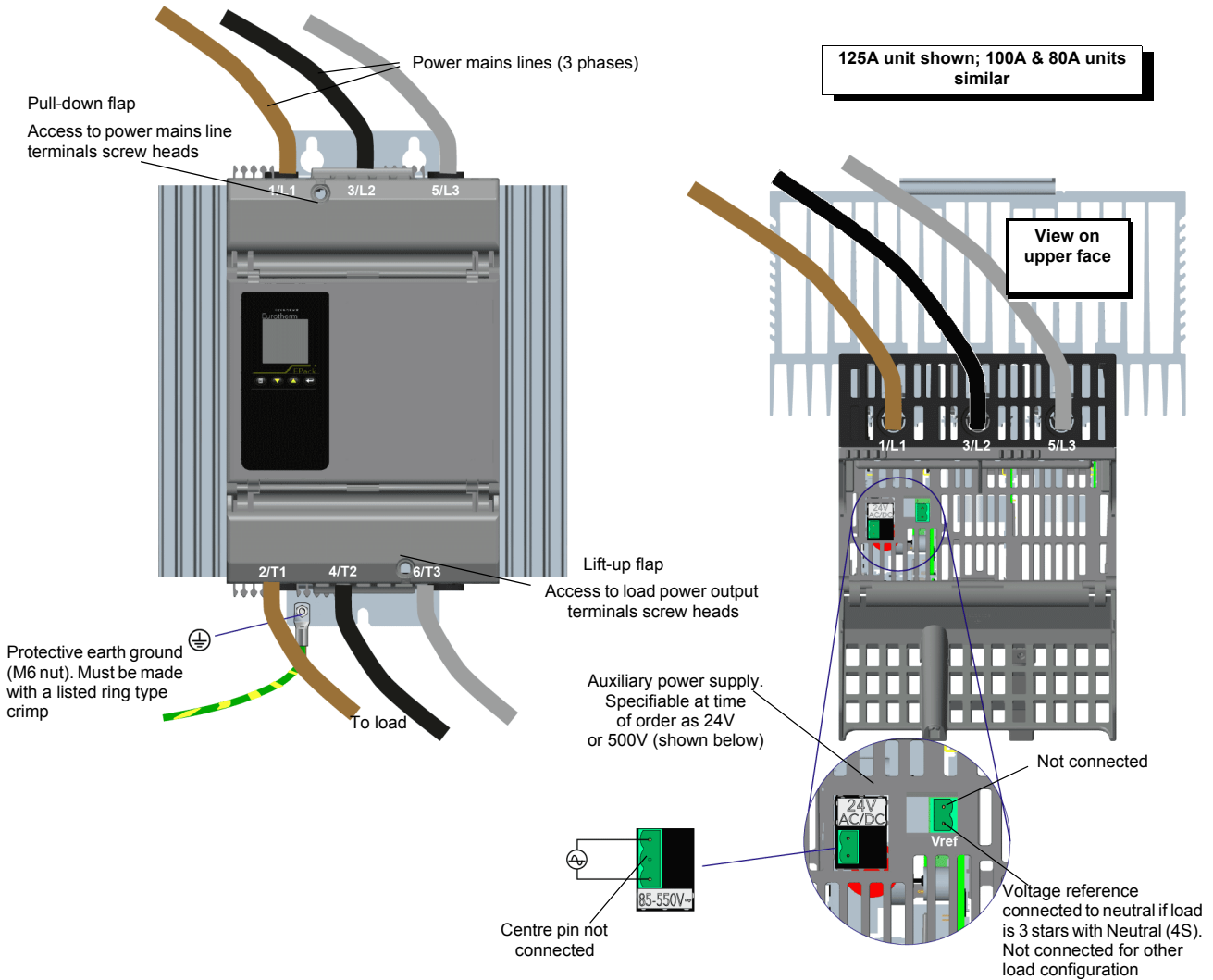

Figure 9 Supply power and Load connection details (80A to 125A units)

See Figure 9 for basic wiring details.

E-Pack rating (Amps)	Exposed conductor length mm (inch)	Remove terminal housing breakaway part? mm (inch) cable diameter	Cable diameter maximum mm (inch)
16A to 63A	20 - 23 (0.79 - 0.91)	Yes, for cables greater than 9 (0.35)	10.5 (0.41)
80A to 125A	20 - 23 (0.79 - 0.91)	Yes, for cables greater than 9 (0.35)	17.5 (0.69)

Table 2: E-Pack cable connection specification

# Load Configurations

## Delta

### Closed Delta

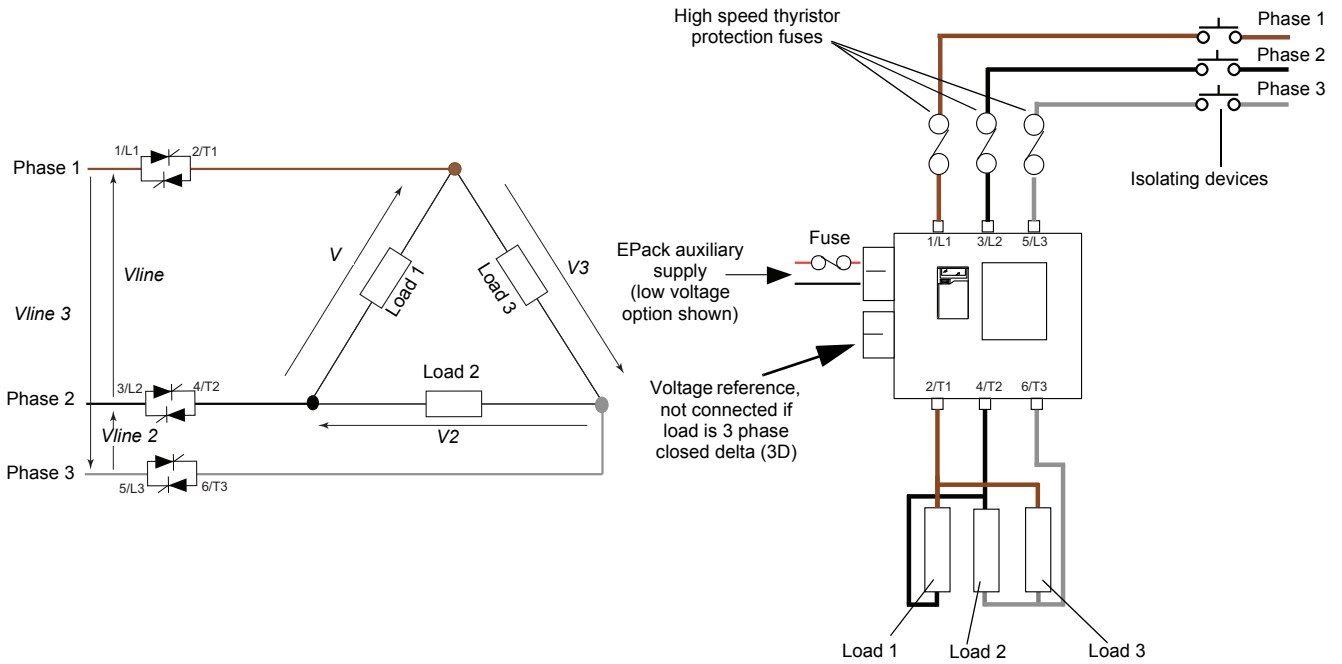

Figure 10 3 phase Closed Delta wiring scheme/load configuration

### Open Delta

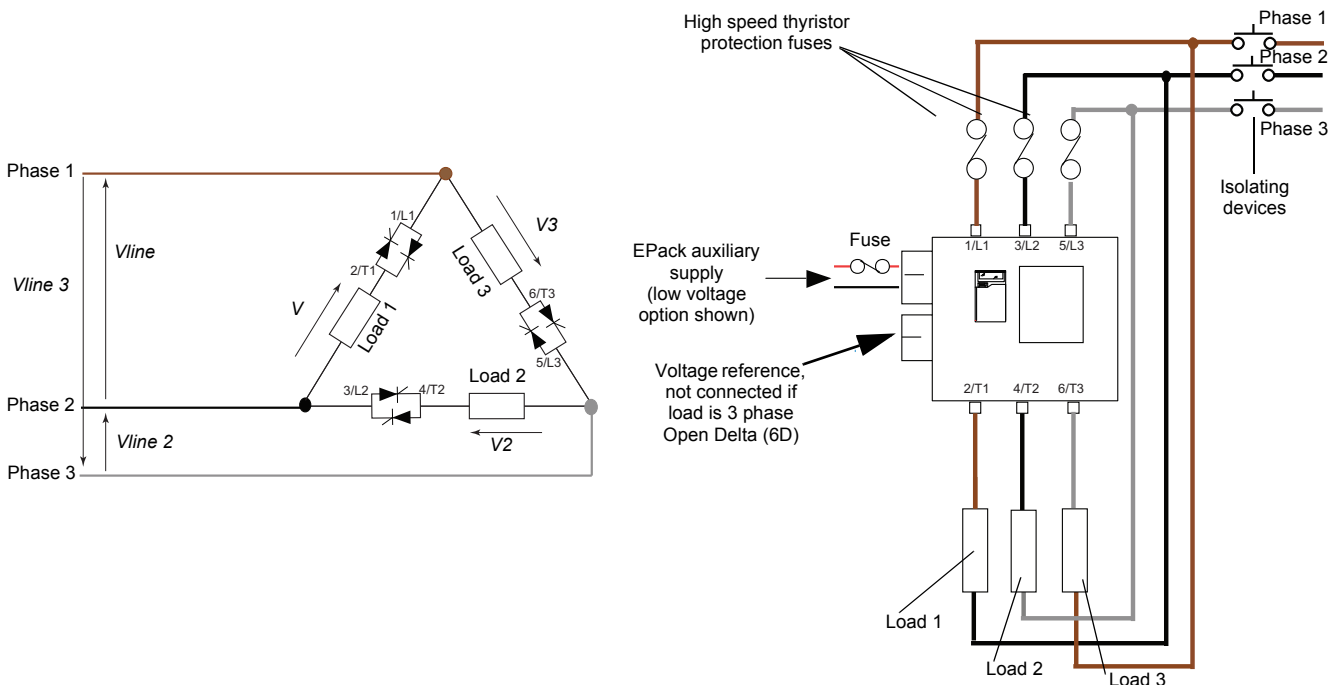

Figure 11 3 phase Open Delta wiring scheme/load configuration

# Star

## Star with Neutral

CE: Wire conductor cross sections must comply with IEC 60364-5-52 or applicable national standards.

U.L.: Wire conductor cross sections must comply with NEC Table 310.15(B)(16) (formerly Table 310.16) taking account of table 310.15(B)(2) for the ampacity correction factors or NFPA79 Table 12.5.1 taking account of Table 12.5.5(a) for the ampereage correction factors or applicable national standards.

**⚠ DANGER**

**HAZARD OF FIRE**

- For 4S load type, the cross-sectional area of the neutral conductor, shall be sized to carry the maximum phase current.

**Failure to follow these instructions will result in death or serious injury.**

Calculate the maximum current of the load by taking account of load resistive tolerance (tolerance and variation due to temperature) and voltage tolerance.

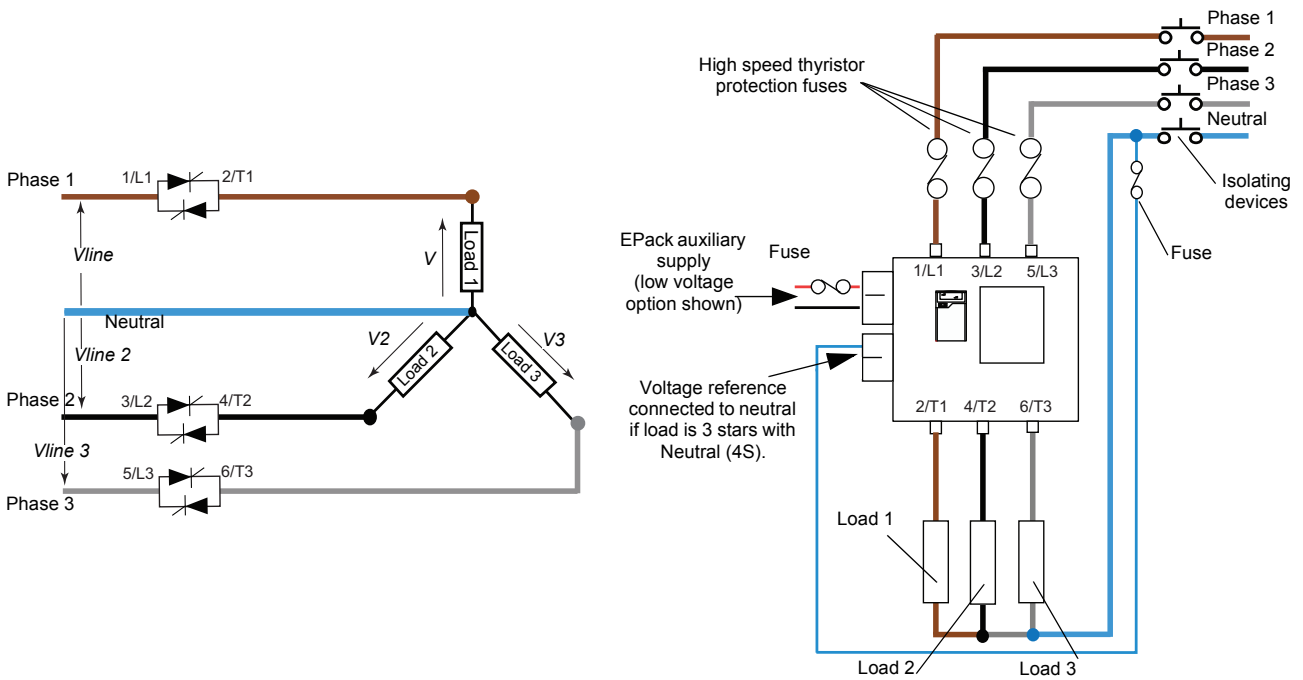

Figure 12 3 phase Star with Neutral wiring scheme/load configuration

### Star without Neutral

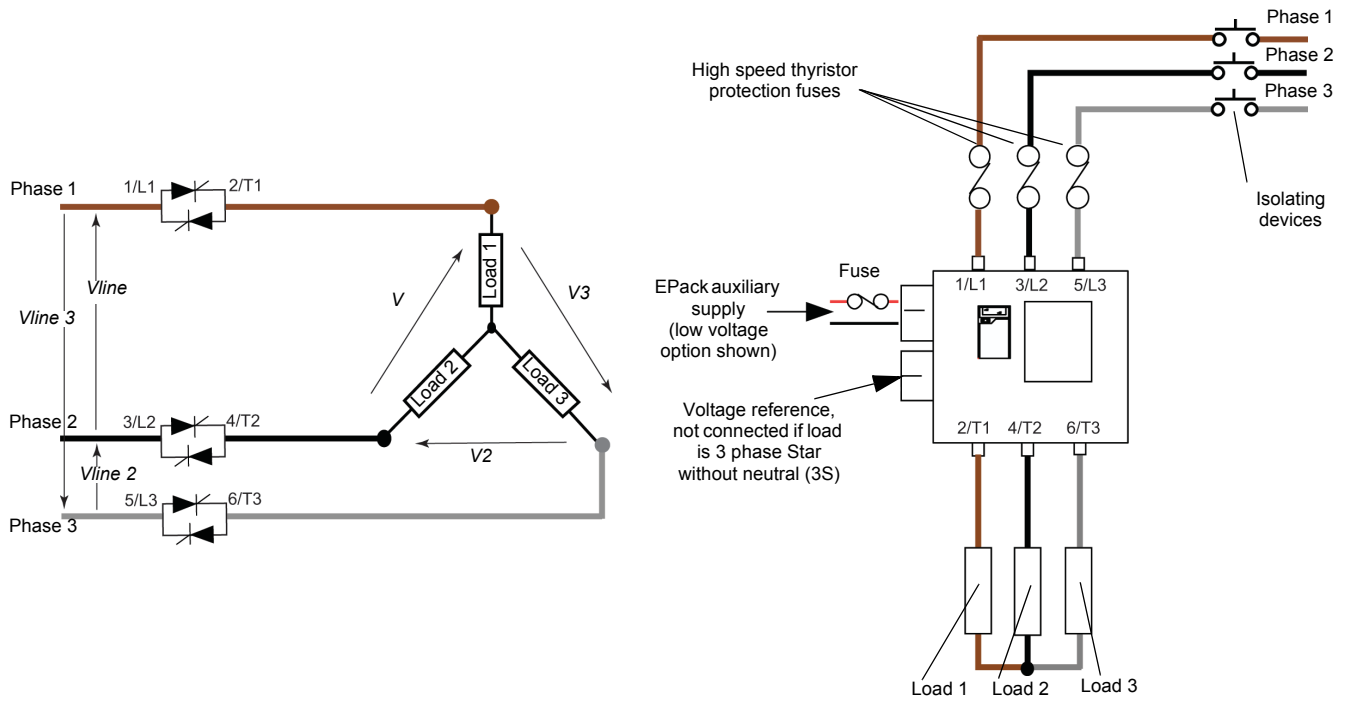

Figure 13 3 phase Star without neutral wiring scheme/load configuration

## Signal wiring

Figure 14 shows the connector location, on the underside of the unit, for the digital and analog inputs, and for the internal relay output.

### Firing Enable

For the power module thyristors to operate, the Firing Enable must be enabled.

In the default configuration Digital input 1 is used to enable the firing and is configured in contact closure type. Therefore, Firing Enable is achieved by shorting pins 0V and DI1 of the I/O connector located on the underside of the unit (Digital input 1).

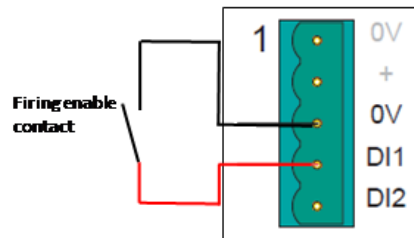

QuickCode menu allows the user to select Digital input 2 to Enable Firing. Digital input 2 is configured in contact closure type, therefore, Firing Enable is achieved by shorting pins 0V and DI2 of the I/O connector located on the underside of the unit (Digital input 2).

If none of them have been selected, firing is enabled internally.

### Alarm Acknowledge

In the default configuration, shorting pins 0V and DI2 of the I/O connector located on the underside of the unit (Digital input 2) acknowledges alarms. This can be done also using DI1.

DI can be configured as a voltage input (if required), and in this case it requires a high signal to be applied to DI with the relevant zero voltage connected to 0V.

### Main Setpoint

In the default configuration, the analog input sets the main setpoint.

### Relay Output

The relay is normally energized (Common and Normally Open pins shorted), and is de-energized (Common and Normally Closed pins shorted) when active. In the default configuration, the relay output is operated by the Fault detect 'Custom Alarm' becoming active.

By default, the Custom alarm is set up to be equivalent to 'AnySystemAlarm' which becomes active if any 'stop firing' conditions, such as those listed below, is detected.

In configuration mode, it is also possible to configure the relay using the Alarm Relay menu in the Operator Interface ().

1. Missing mains. Supply voltage line is missing.
2. Thyristor short circuit<sup>a</sup>

3. Network dips. A reduction in supply voltage exceeding a configurable value (VdipsThreshold), causes firing to be inhibited until the supply voltage returns to a suitable value. VdipsThreshold represents a percentage change in supply voltage between successive half cycles.
4. Freq out of range. The supply frequency is checked every half cycle, and if the percentage change between successive half cycles exceeds a threshold value (max. 5%), a Mains Frequency System Alarm is generated.
5. Supply failure detected to EPack unit.
6. Chop Off ([page 61](#))
7. Analog input over current. For mA inputs this alarm is active if there is too high a current flowing through the shunt.
8. Line under voltage (of nominal voltage).
9. Line over voltage (of nominal voltage).
10. Over current (of nominal current).

The relay is de-energized temporarily then re-energized at start-up.

- a. It is not possible to detect a thyristor short circuit when the unit is delivering 100% output power.



## I/O Input & Output Details

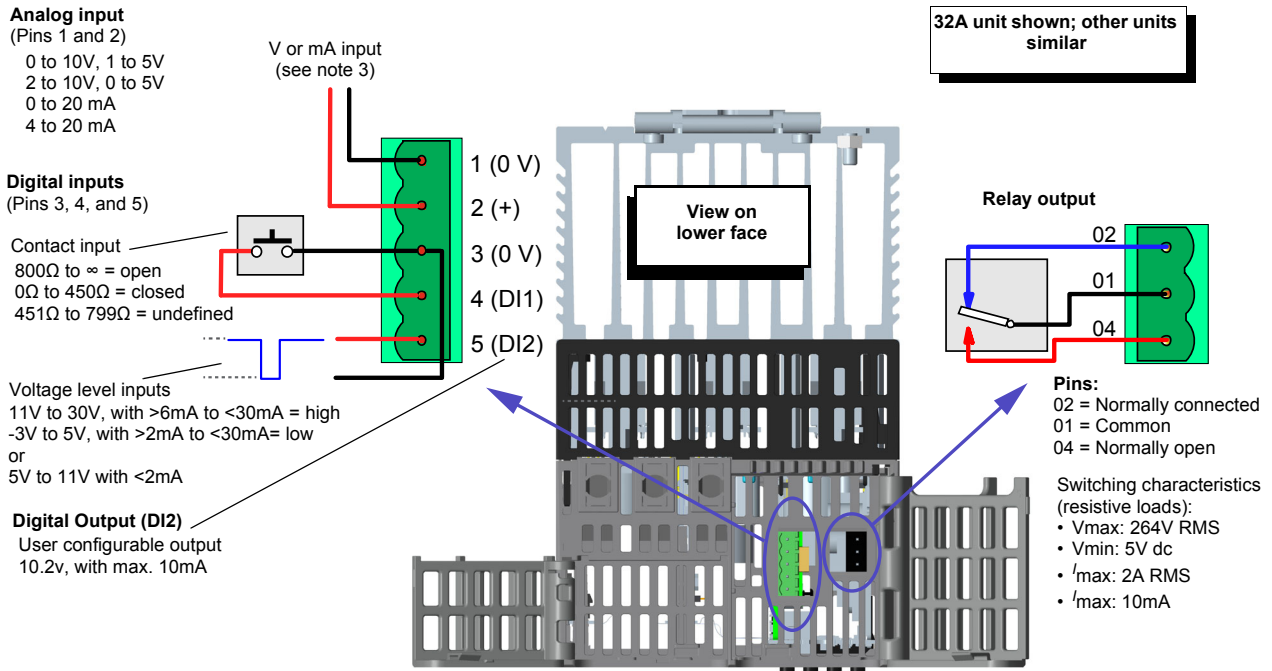

Figure 14 I/O details

**Notes:**

1. Diagram shows DI1 as a contact input and DI2 as a voltage level input.
2. DI1 can be configured as contact inputs or voltage inputs.
3. DI2 can be configured as contact inputs or voltage inputs or 10.2V output (with max. 10mA).
4. Analog input type (Volts or mA) is selected in I/O Analog IP configuration. When a mA range is selected, a suitable shunt resistor is automatically connected to circuit. It is thus unnecessary for the user to fit external components.

⚠ **DANGER**

**HAZARD OF ELECTRICAL SHOCK, EXPLOSION OR ARC FLASH**

- Do not exceed the device's ratings
- The I/O Input & Output, the Communications ports are SELV circuit. They must be connected to SELV or PELV circuit.
- The relay output and the fuse holders contacts are compliant to the SELV requirements; they can be connected to SELV, PELV circuit or to voltage up to 230V (maximum value of rated operational voltage to earth:230V).

**Failure to follow these instructions will result in death or serious injury.**

SELV is defined (in IEC60947-1) as an electrical circuit in which the voltage cannot exceed 'ELV' under normal conditions or under single fault conditions, including earth ground faults in other circuits.

The definition of ELV is complex as it depends on environment, signal frequency, etc. See IEC 61140 for further details.

## Fuse Holders Contact Data (Fuse Ordering Code HSM)

⚠ **DANGER**

HAZARD OF ELECTRICAL SHOCK, EXPLOSION OR ARC FLASH

- Do not exceed the device's ratings.
- The relay output and the fuse holders contacts are compliant to the SELV requirements; they can be connected to SELV, PELV circuit or to voltage up to 230V (maximum value of rated operational voltage to earth:230V).

Failure to follow these instructions will result in death or serious injury.

SELV is defined (in IEC60947-1) as an electrical circuit in which the voltage cannot exceed 'ELV' under normal conditions or under single fault conditions, including earth ground faults in other circuits.

The definition of ELV is complex as it depends on environment, signal frequency, etc. See IEC 61140 for further details.

If fuse ordering code HSM has been selected, the fuses holder is delivered with a contact kit which provides indication if the fuse is blown or missing. This is shown locally on the fuseholder by a red handle which also activates microcontacts. These contacts may be wired to a digital input on the EPack as shown in the following diagrams.

Fuses Holders Contacts Kit are delivered with NO, NC contact.

Fuse in fuse holder and not blown  
The handle and contacts are in the closed state

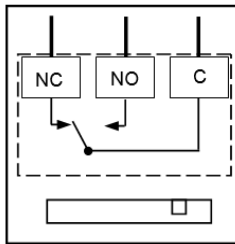

Fuse missing or fuse blown  
The handle is open and shown red. The contacts are in open state

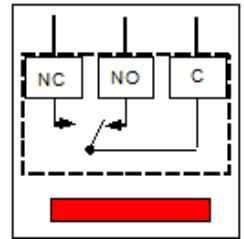

- Connection: Faston lugs 2.8 x 0.5mm (0.11 x 0.02in)
- Rated insulation voltage: 250VAC
- Rated operational current following IEC 60947-5 & -1
- Utilization category AC15: 4A/24V, 4A/48V, 3A/127V, 2.5A/240V
- Utilization category DC13: 3A/24V, 1A/48V, 0.2A/127V, 0.1A/240V

**For contact kit reference according to product rating see Table 3 or Table 4.**

Contact kit Mersen Y227928A, for fuse size 14x51 or Contact kit Mersen G227959A for fuse size 22x58.

Minimum operational current and voltage: 1mA/4V AC or DC.

- These contacts are compatible with Digital inputs configured in contact closure mode.

Recommended wiring:

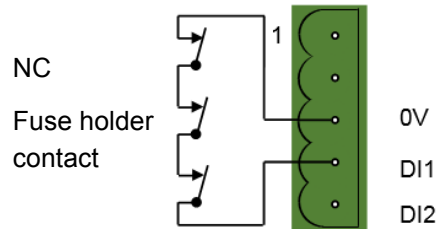

**For contact kit Mersen E227612A, for fuse size 27x60**

Minimum operational current and voltage: 100mA/20V AC or DC

- These contacts are not compatible with Digital inputs configured in contact closure mode.
- These contacts are compatible with Digital inputs configured in Voltage inputs with external dc power supply and load 100 mA dc minimum.

Recommended wiring:

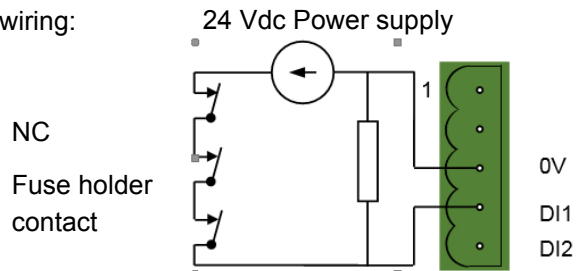



# Operator Interface

Located at the front of the Driver Module, the operator interface consists of a square display, and four pushbutton switches.

## Display

The display is divided vertically into three areas, which for the purposes of this manual are called the status area at the top, the data display, in the center, and the soft keys at the bottom. This display, together with the four pushbuttons allows full operation and configuration of the unit.

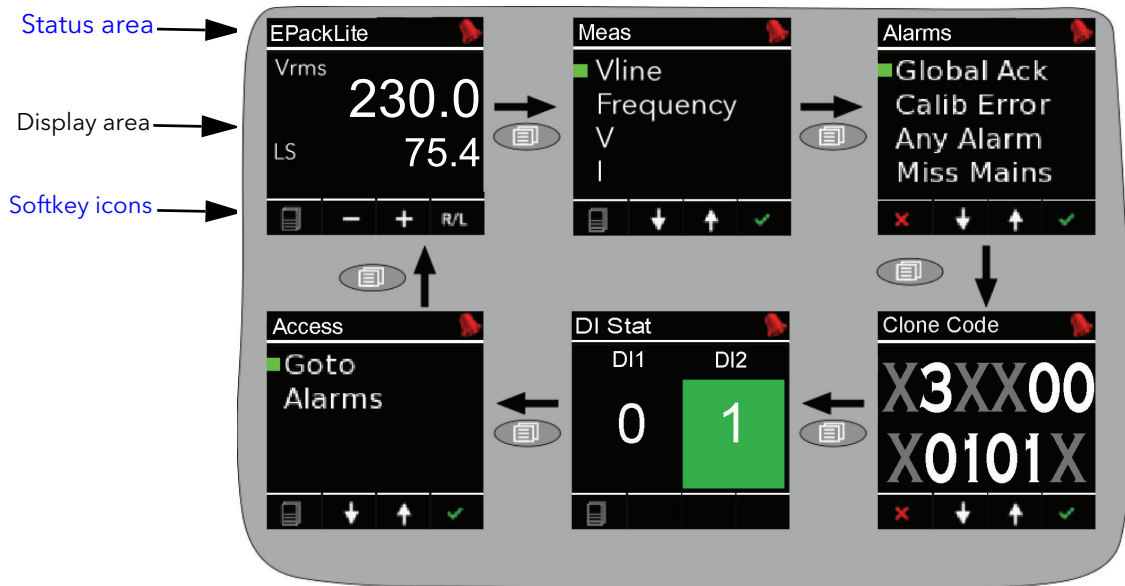

Figure 15 Operator interface

The figure above shows a typical operator mode screen. The other available screens are scrolled through using the return (page) pushbutton. The configuration of the unit defines which parameters actually appear.

The screens are displayed in the following order:



1. E-Pack Lite Main Screen (as shown in the figure)
2. Meas menu
3. Alarms menu
4. DI Stat

**Notes:**

1. The Alarms display appears only if there are any active alarms. The up/down arrow pushbuttons can be used to scroll through the alarm list, if there are more alarms active than can be displayed on one screen height.
2. The 'Goto' item allows the user to enter Configuration mode, providing the known.

## Status area

This area at the top of the screen contains text descriptive of the current operation, and a number of icons as follows

-  Configuration key. Displayed when the unit is in configuration mode.
-  Alarm symbol. Indicates that one or more alarms is active.

## Softkey icons

A number of icons can appear at the bottom of the display, and each icon represents the action of the pushbutton immediately below it.



Menu. This appears in the bottom left corner, and operation of the Return pushbutton causes the top level menu to appear.



Return. This red cross icon appears in the bottom left corner, and operation of the Return pushbutton causes any configuration changes on the current page to be 'undone' or, if none, causes the display to 'go up' one level.



Plus and minus icons. Operation of the associated scroll up/down pushbutton causes the displayed value to increment or decrement.



Up/down arrows. Operation of the associated scroll up/down pushbutton causes the various menu items on display to be scrolled through.



Right/Left arrow. The right-pointing arrow appears in the bottom right-hand corner, and operation of the Enter pushbutton causes the cursor to shift right. Once this has been done, a left-pointing arrow appears in the bottom left-hand corner, allowing the user to shift the cursor to the left using the Return pushbutton.



Enter. This green tick appears in the bottom right corner, and operation of the Enter pushbutton causes any configuration change(s) on the display page to be confirmed.



Remote/Local. This appears in the bottom right corner, and operation of the Enter pushbutton toggles the setpoint selection between local and remote.

## Pushbuttons

The functions of the four pushbuttons below the display depend on what is displayed in the softkey area. The leftmost pushbutton (Return) is associated with the leftmost soft key, the down arrow pushbutton is associated with the next soft key and so on. In the example above, the 'Return' key is used both to enter the Menu, and to return from it to the initial display.

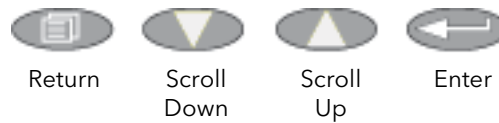

### Pushbutton functions

Return	Returns to previous menu (while menus are displayed), cancels editing (during parameter editing), and performs screen cycling (during operator mode).
Scroll down/up	Allows the user to scroll through the available menu items or values.
Enter	Goes to next menu item. In parameter edit mode, this button confirms the changes.

### Menu item value selection

Menu items are scrolled through using the up/down pushbuttons. Once the required item is displayed, the Enter pushbutton is used to select it for editing. Editing of the item's value is carried out by scrolling through the available choices, using the up and down scroll keys. Once the desired value is displayed, the Enter pushbutton is used to confirm the choice.

Where multiple changes have to be made (as in editing an IP address for example), the Enter pushbutton acts as a right cursor key, moving from the field just edited to the next field. (The Return pushbutton moves the cursor left). Once all fields have been edited, the Enter pushbutton is used a final time to confirm the choice.

## Front Panel Event Indication

A number of instrument alarms and events can occur, and these are indicated by icons appearing on the display screen. The events and alarms are listed below. See [Alarms \(page 80\)](#) for a more details.

### Instrument events

Conf Entry	The instrument has been placed in configuration mode (cogwheel symbol).
Conf Exit	The instrument has been taken out of configuration mode (no icon).
GlobalAck	A global acknowledgement of all latched alarms has been performed.
Quick Code Entry	The Quick Code menu is active (cogwheel icon + 'QCode' in display area).

The following alarms all cause a red bell icon to appear in the top right hand corner of the screen.

### Indication alarms

LoadOverl	An over current alarm has become active in one or more Network blocks.
-----------	--

### System alarms

ChopOff	The 'Chop-off' alarm has been detected.
FuseBlown	There is no internal fuse, but it is possible to use DI2 as a 'fuse-blown' input wired to the alarm block in iTools.
MainsFreq	Mains Frequency is outside the acceptable range.
Missmains	Supply power is missing.
NetwDip	The 'network dip' alarm has been detected.
Thyr SC	Thyristor short circuit. It is not possible to detect a thyristor short circuit when the unit is delivering 100% output power.

### Process alarms

ClosedLp	The Control block 'Closed Loop' alarm has been detected.
Ana_In Over C	Over current in shunt. If this alarm is detected, firing is stopped by default and Analog Input type is automatically switched to 0-10V mode to avoid damage.
Under Volt	Line under voltage
Over Volt	Line over voltage (configurable between 2 and 10% of nominal voltage)
PLF	The 'Partial Load Failure' alarm has been detected.
TLF	The 'Total Load failure' alarm has been detected.



# Quickcode

At first switch-on, the E-Pack unit enters the 'QuickCode' menu which allows the user to configure the major parameters without having to enter the full configuration menu structure of the unit. Figure 16 shows an overview of a typical QuickCode menu. The actual displayed menu items will vary according to the number of software features purchased. When 'Finish' is selected to 'Yes', the instrument cold starts after confirmation (Enter key); when set to 'Cancel' the instrument discards any changes and restarts with the previous configuration.

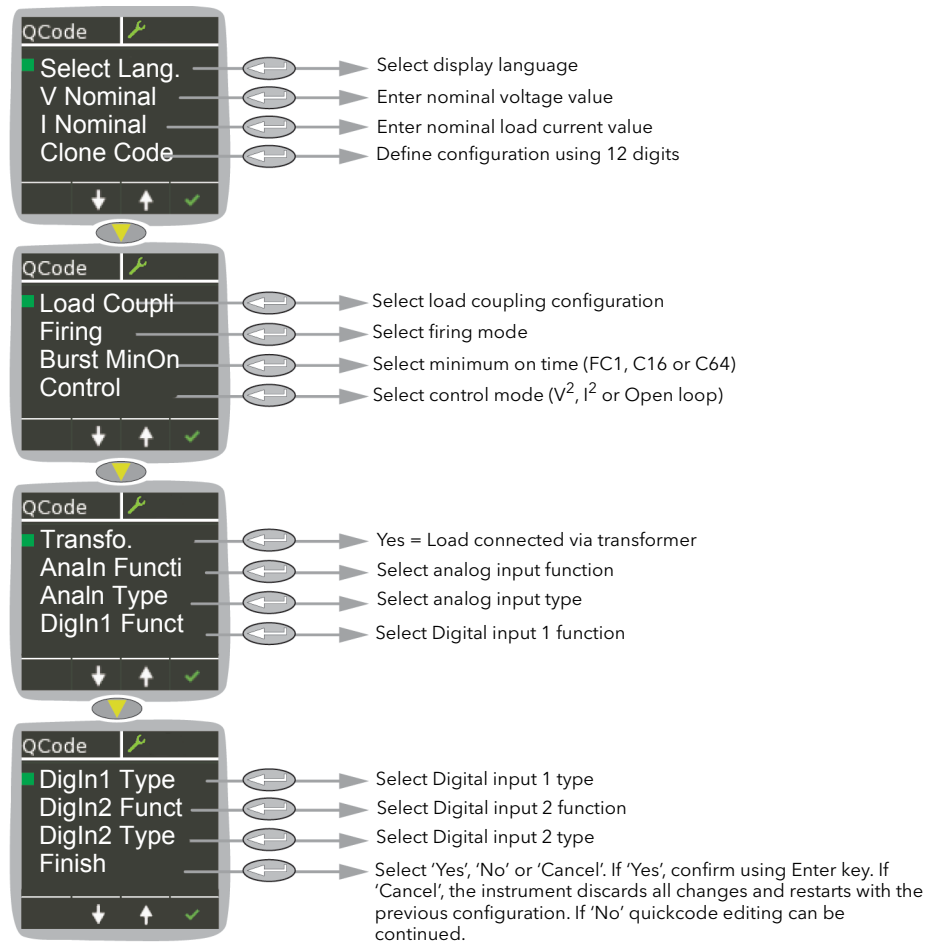

Figure 16 Typical QuickCode menu

**Notes:**

1. If the unit has been fully configured at the factory, the Quickcode menu will be skipped, and the unit will go into operation mode at first switch on.
2. Once quit, the Quickcode menu can be returned to at any time from the Access menu via the front panel. Returning to the Quickcode menu cold-starts the unit.

## Quickcode Menu Parameters Description

Language	Select English, French, German, Italian or Spanish. Once confirmed all further displays appear in the selected language.
V Nominal	The nominal value of the supply voltage (valid entries are 20V to 500V). Default value appears. Use the up/down arrow buttons to edit.
I Nominal	The current flowing through the load according to the nominal load power. This current must not exceed the maximum current the unit has been designed for. Lower values are not recommended as in such cases, the resulting accuracy and linearity may not be within specification. Default value appears. Use up/down arrow buttons to edit.
Load Coupling	Select one of the following; 3D (closed Delta), 3S (Star without Neutral), 4S (Star with Neutral) and 6D (open Delta). See <a href="#">Load Configurations (page 44)</a> for more details.
Clone Code	Define the configuration of the unit simply by using 12 digits. By setting these 12 digits (copied from another unit, for example), the product will be fully configured. It is a quick way to clone a configuration from another unit.
Firing Mode	Select from IHC (Intelligent Half Cycle), Burst Var (Burst Variable), Burst Fix (Burst Fixed), Logic or Phase Angle. Note that in Burst fixed firing mode, the modulation period is set to 2 seconds.
Burst MinOn	Select the minimum on-time for the burst variable between 1, 16 and 64 mains cycles.
Control	Select VSq ( $V^2$ ), Isq ( $I^2$ ), or Open Loop
XFMR (Transfo.)	No = Resistive load type; Yes = Transformer primary.
Analn Functi	Select SP (setpoint) or None (no function) as Analog Input function

**Note:** Setpoint is only available for Analn Functi if DI1 or DI2 Fct are not set to 'Setpoint' while Firing Mode is set to 'Logic'.

Analn Type	Select 0 to 10V, 1 to 5V, 2 to 10V, 0 to 5V, 0 to 20mA or 4 to 20 mA as analog input type.
DI1 Fct	Select 'Firing Enable', Alarm ack(nowledge), RemSP sel (select remote setpoint), Fuse Blown, Setpoint (in logic mode) or none.

### Notes:

- The function is available if not set in DI2.
- Setpoint is only available for DigIn1 Function if Analn or DI2 Fct is not set to 'Setpoint' whilst Firing Mode is set to 'Logic'

DigIn1 Type	Select from IpContact (Input contact) and IpVolts (Input volts)
DI2 Fct	Select Firing Enable, Alarm ack(nowledge), RemSP sel (select remote setpoint), Fuse Blown, Setpoint, 10V user output, Firing Enable or none.

### Notes:

- Setpoint is only available for DI1 Fct or DI2 Fct if Analn Functi is not set to 'Setpoint' while Firing Mode is set to 'Logic'.
- DI1 Fct and DI2 Fct are mutually exclusive.

DigIn2 Type	Select from IpContact (Input contact) and IpVolts (Input volts)
Finish	If 'Yes' is selected (and confirmed using the enter key),

quick code exits and the instrument restarts with the new configuration. If 'No' is selected then no action is taken and the user can continue to edit the quick code parameters. If 'Cancel' is selected then all changes are discarded, quick code exits and the instrument restarts with the previous (i.e. unedited) configuration.

## Firing modes definitions

### Logic

Power switches on, two or three zero crossings of the supply voltage after the logic input switches on. Power switches off, two or three zero crossings of current after the logic input switches off. For resistive loads, voltage and current cross zero simultaneously. With inductive loads, a phase difference exists between the voltage and current, meaning that they cross zero at different times. The size of the phase difference increases with increasing inductance.

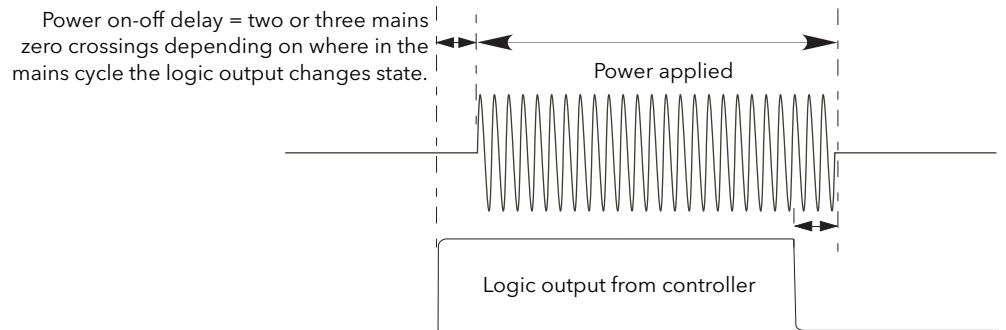

Figure 17 Logic firing mode

### Burst Fixed Firing

This means that there is a fixed 'cycle time' equal to an integer number of supply voltage cycles as set up in the Modulator menu. Power is controlled by varying the ratio between the ON period and the OFF period within this cycle time (Figure 18).

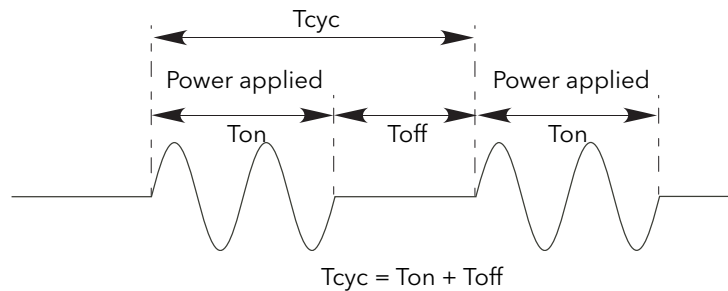

Figure 18 Burst Fixed mode

## Burst Variable Firing

Burst Firing Variable is the preferred mode for temperature control. Between 0 and 50% of setpoint, the ON time is the 'Min on' time set in the modulator menu and the OFF time is varied to achieve control. Between 50% and 100%, the OFF time is the value set for 'Min on' and power is controlled by varying the number of ON cycles.

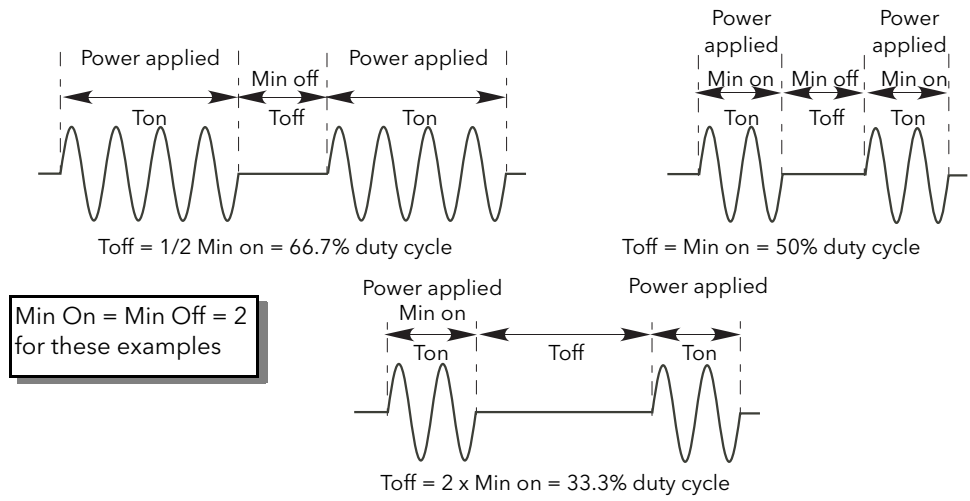

Figure 19 Burst variable firing

## Feedback type

All feedback types (except 'Open Loop') are based on real-time measurement of electrical parameters that are normalized to their equivalent Nominal values.

$V^2$	Feedback is directly proportional to the square of the RMS voltage measured across the load.
$I^2$	Feedback is directly proportional to the square of the RMS current through the load. For two- or three-phase systems, feedback is proportional to the average of the squares of the individual RMS load currents.
Open loop	No measurement feedback. The thyristor firing angle in Phase angle mode, or the duty cycle in burst-firing mode, are proportional to the setpoint.

## Chop Off Definition

This is a technique which detects an over-current alarm state and stops further thyristor firing for the duration of that alarm state.

The conditions that trigger a Chop Off alarm are:

1. When the ChopOff Threshold exceeds the number of times specified in NumberChop Off parameter. NumberChop Off is set to 10. The ChopOff Threshold is set to 120%.

When the alarm is triggered the unit stops firing and raises a chop off alarm. Firing is not resumed until the operator acknowledges the Chop Off alarm, to restart.



## Configuration from the Front Panel

At power up or after quitting the Quickcode menu, the unit initializes and then enters the summary page (Figure 20) showing the real-time values of the two parameters configured, see "Instrument Display configuration" on page 159 for details.

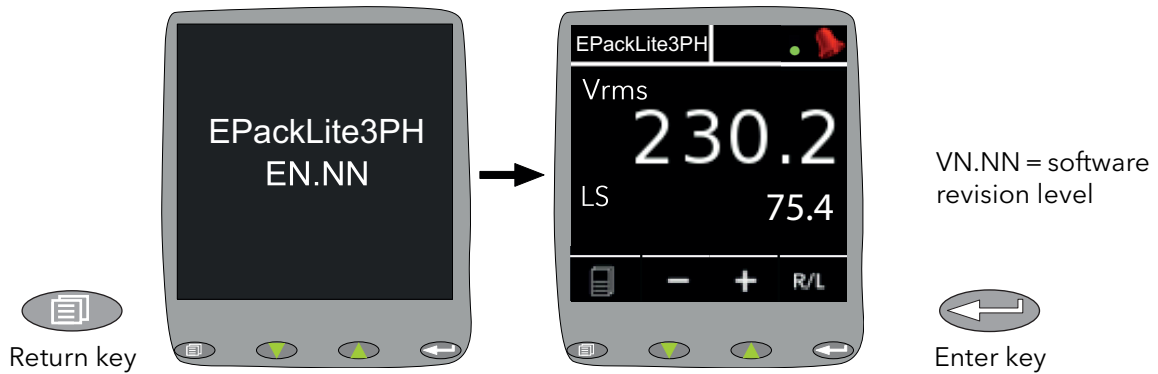
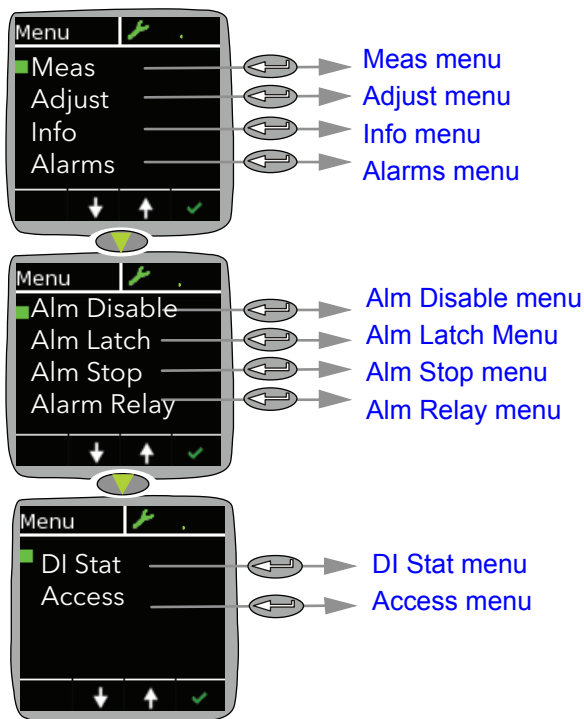

Figure 20 Initialization screens

## Menu Pages

Operating the return key opens the first page of the menu, the content of which depends on the current access level and on the number of options enabled.





# Meas menu

This menu allows the user to view a number of measured values in real time.

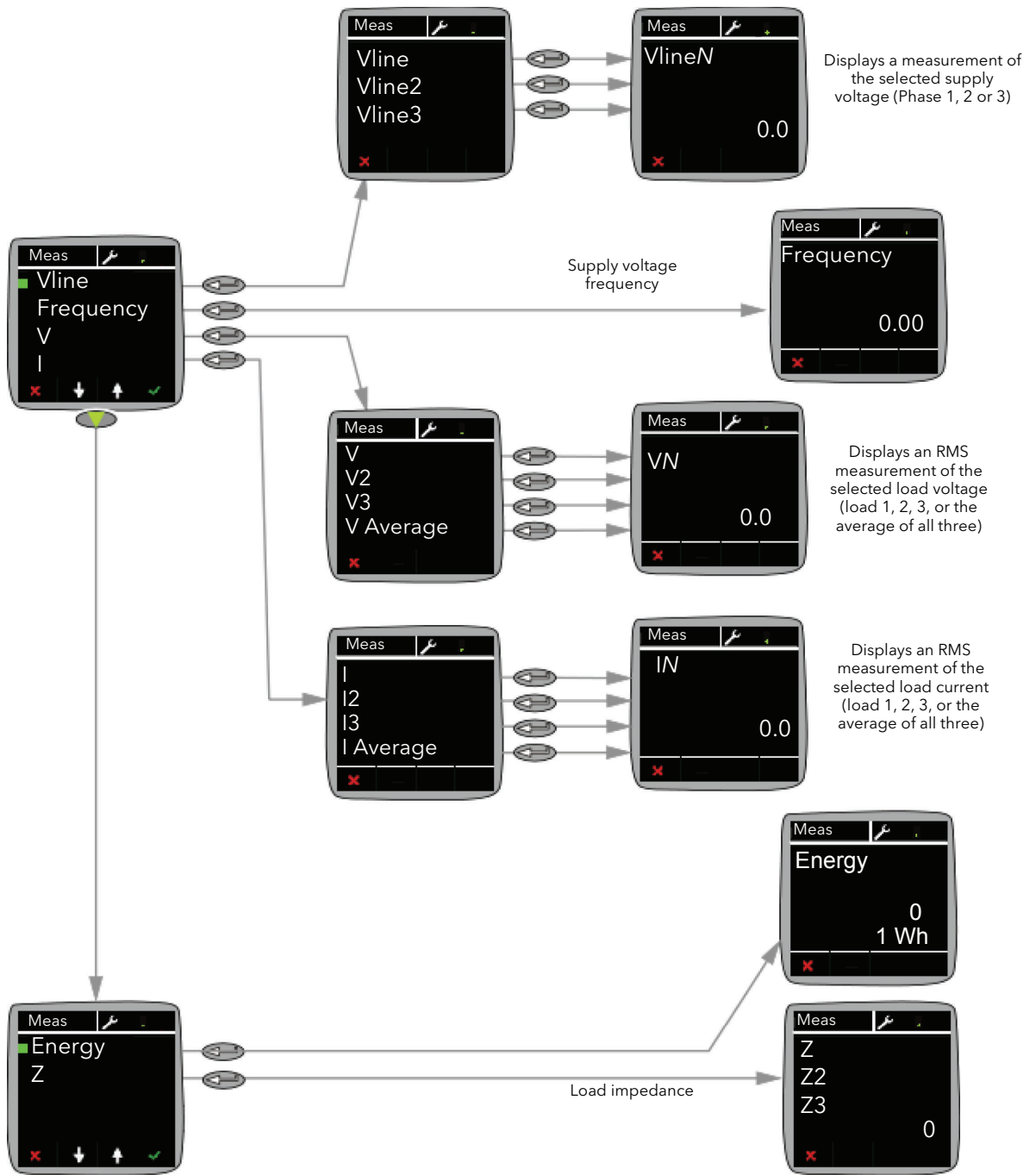

Figure 21 Meas menu

# Adjust menu

This menu allows a number of network and firing output parameters to be set up, as well as Analog input type.

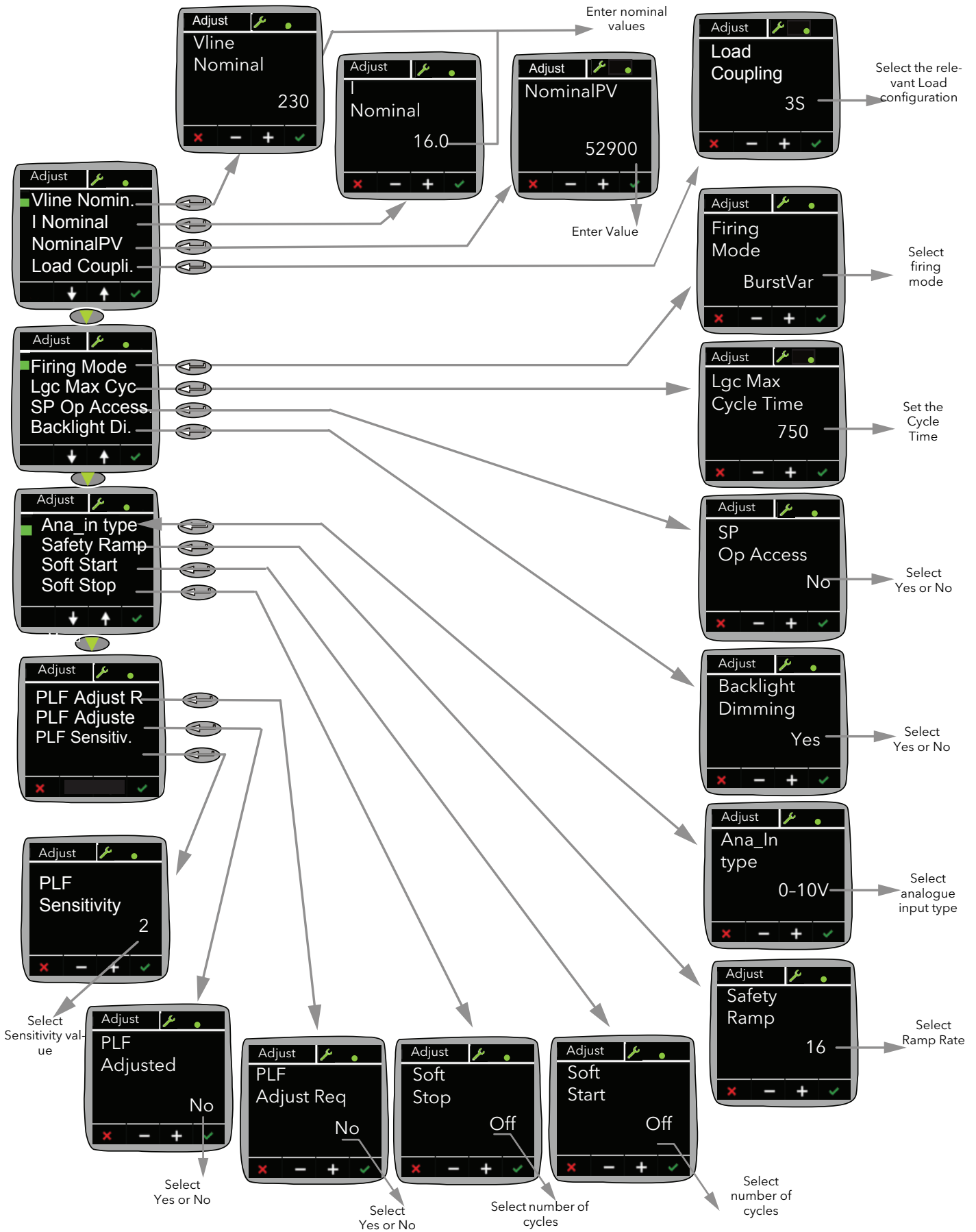

Figure 22 Adjust menu

Vline Nominal	Line voltage nominal value (Line to line for all listed configurations, except Star with Neutral (4S) which is Line to neutral), see <a href="#">Load Configurations (page 44)</a> .
I Nominal	Nominal current supplied to the load.
NominalPV	Nominal Process Variable. Defines the nominal value for each control type. For example, for Vsq control, you must set NominalPV to the nominal value you expect for Vsq—typically this could be VloadNominal * VloadNominal.
Load Coupling	Allows you to specify how the load is configured on your installation. Select one of the following; 3D (closed Delta), 3S (Star without Neutral), 4S (Star with Neutral) and 6D (open Delta). See <a href="#">Load Configurations (page 44)</a> for more details.
Lgc Max Cyc	Max cycle time for Logic mode. This is set in mains periods. This is the equivalent to the modulation period and it is used to compute Network electrical quantities when there is no modulation shift. It is only available in Logic Mode.
Firing Mode	Firing Mode allows the firing mode to be selected as Burst Var, Burst Fix, or Logic, Phase Angle (PA) or Intelligent half cycle (IHC).
SP Op Access	Setpoint Operator Access: Allows the user setpoint access via the front panel, in operator configuration when enabled. To enable set to Yes. (The default setting is Yes).
Backlight Di.	Backlight Dimming: By default, the backlight on the EPack's display dims automatically to save power. Set this parameter to No if you want the backlight to always remain on. If set to Yes, the backlight dims 30 seconds after you last operate the buttons on the front panel.
Ana_in type	Select the Analog Input type as 0 to 10V, 1 to 5 V, 2 to 10V, 0 to 5V, 0 to 20mA, 4 to 20mA.
'Safety Ramp'	Displays the startup ramp duration, in supply voltage cycles (0 to 255), to be applied at startup. The ramp is either a phase angle ramp from zero to the requested target phase angle or, for Burst Firing, from 0 to 100%. 'Safety Ramp' is not applicable to Half cycle Mode.
Soft Start	For Burst Firing only, this is the soft start duration, in supply voltage cycles, applying a phase angle ramp at the beginning of each ON period.
Soft Stop	In Burst Firing, the soft stop duration, in supply voltage cycles, applying a phase angle ramp at the end of each ON period.
Delay Triggering	Appears only if Mode is Burst, Soft Start is Off, and Load Type is TxFormer. Delayed Trigger specifies the triggering delay, in phase angle, when delivering power into a transformer load. Used to minimize inrush current, the value is configurable between 0 and 90 degrees, inclusive.
PLF Adjust R	Partial Load Failure Adjustment Request: When the process has achieved a steady state condition the operator must set the PLFAdjustReq. This makes a load impedance measurement to be used as a reference for detecting a partial load failure. If the load impedance measurement is successful 'PLFAdjusted' is set. The measurement cannot be made if the load voltage (V) is below 30% of VNominal or if the current (I) is below 30% of INominal. The input is edge sensitive, so if the request is made from external wiring, and the input remains permanently at a high level, only the first 0 to 1 edge is taken into account.

PLF Adjusted

Partial Load Failure Adjusted: A successful load impedance measurement has been made (see PLF Adjust R above).

PLF Sensitivity

Partial load failure sensitivity. This defines how sensitive the partial load failure detection is to be as the ratio between the load impedance for a PLFadjusted load and the current impedance measurement. For example for a load of N parallel, identical elements, if the PLF Sensitivity (s) is set to 2, then a PLF alarm will occur if N/2, or more elements are broken (i.e. open circuit). If PLF Sensitivity is set to 3, then a PLF alarm occurs if N/3 or more elements are broken. If (N/s) is non-integer, then the sensitivity is rounded up. E.G. if the N = 6 and s= 4, then the alarm is triggered if 2 or more elements are broken.

## Examples

### Safety Ramps, Soft Start and Delayed Trigger, firing types

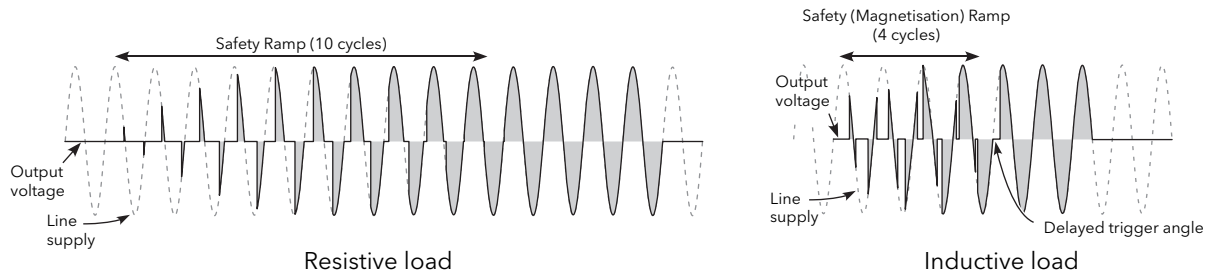

Figure 23 Safety ramp (burst firing) examples

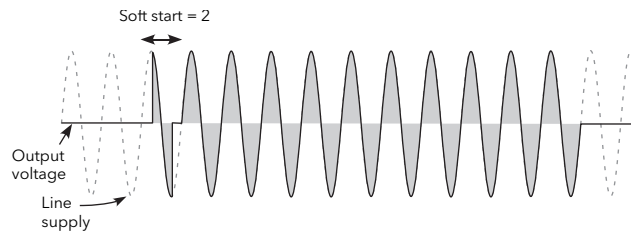

Figure 24 Soft start example

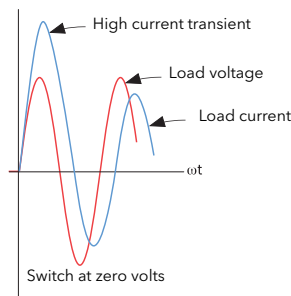

Figure 25 Delayed trigger definition

**Note:** Waveforms have been idealized for clarity.

## PLF menu

The PLF (Partial Load Failure) menu is only available in Engineer mode.

**Note:** The default Engineer access level code is 2.

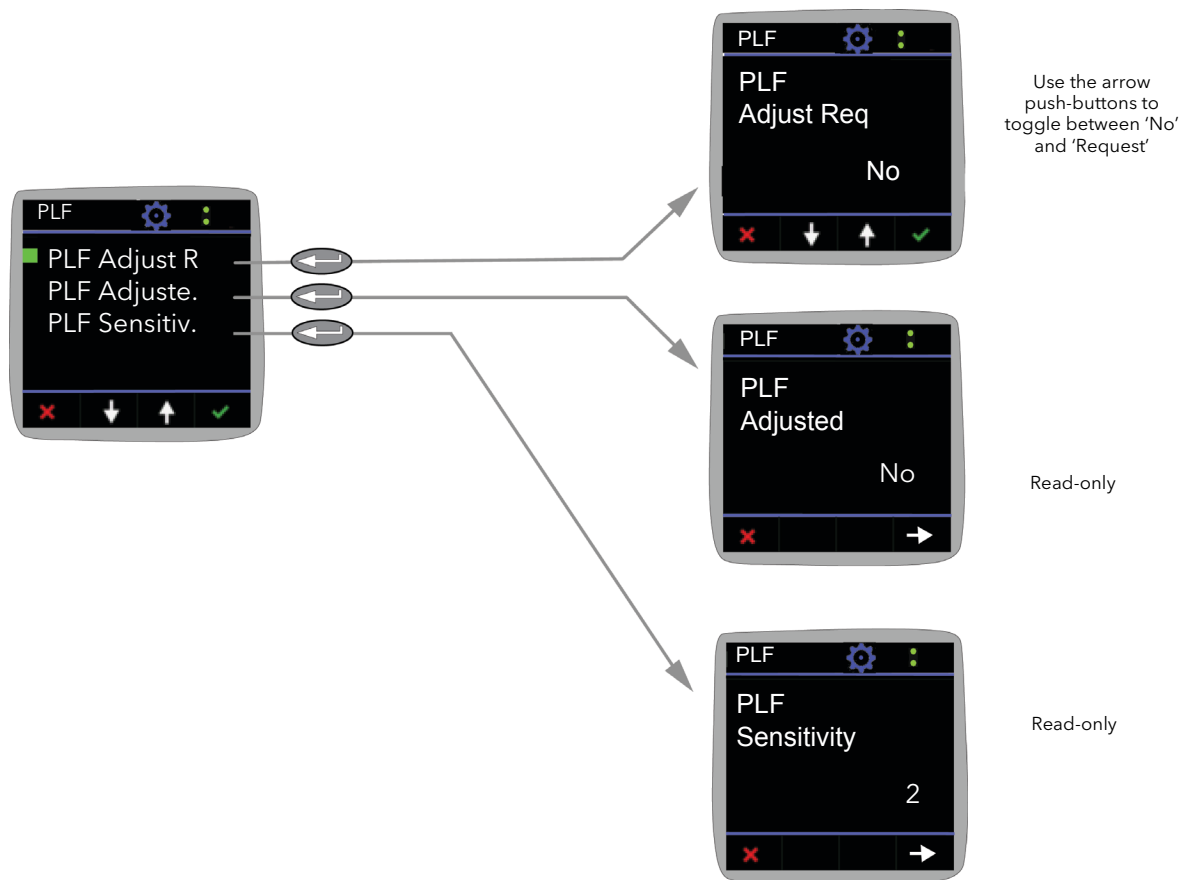

Figure 26 PLF menu

## Info menu

This display gives read only information about the unit.

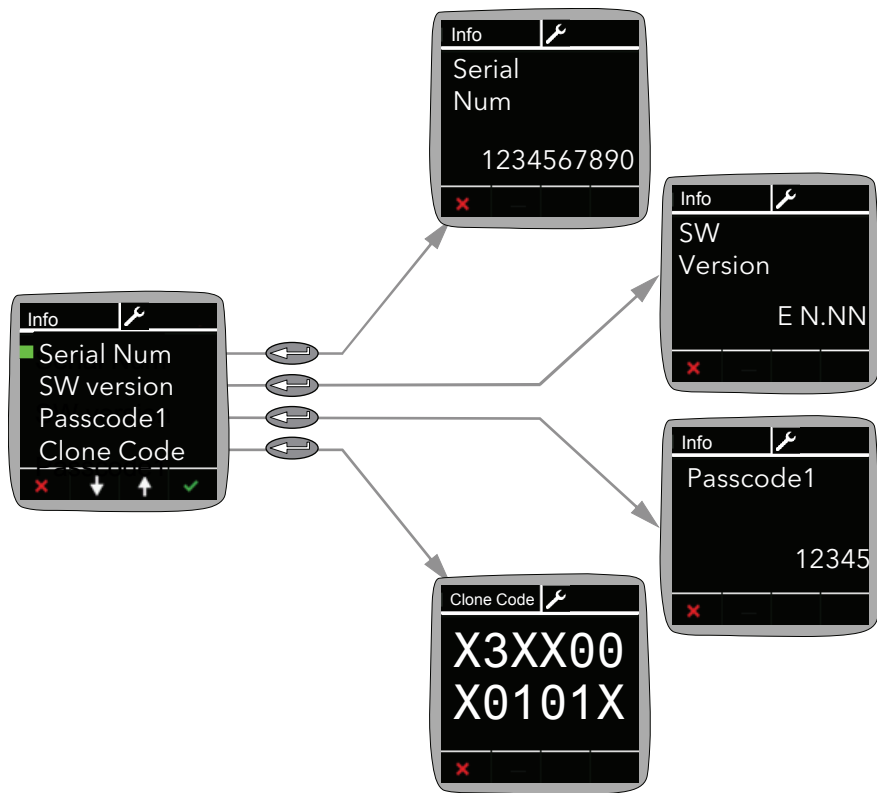

Figure 27 Info menu

## Alarms menu

Allows the user to view Global acknowledgement enable status, and issues with calibration (if any). Any active alarms appear, and details can be found by highlighting the relevant alarm and using the Enter pushbutton.

Active alarms can be acknowledged, if applicable, by a further operation of the Enter button.

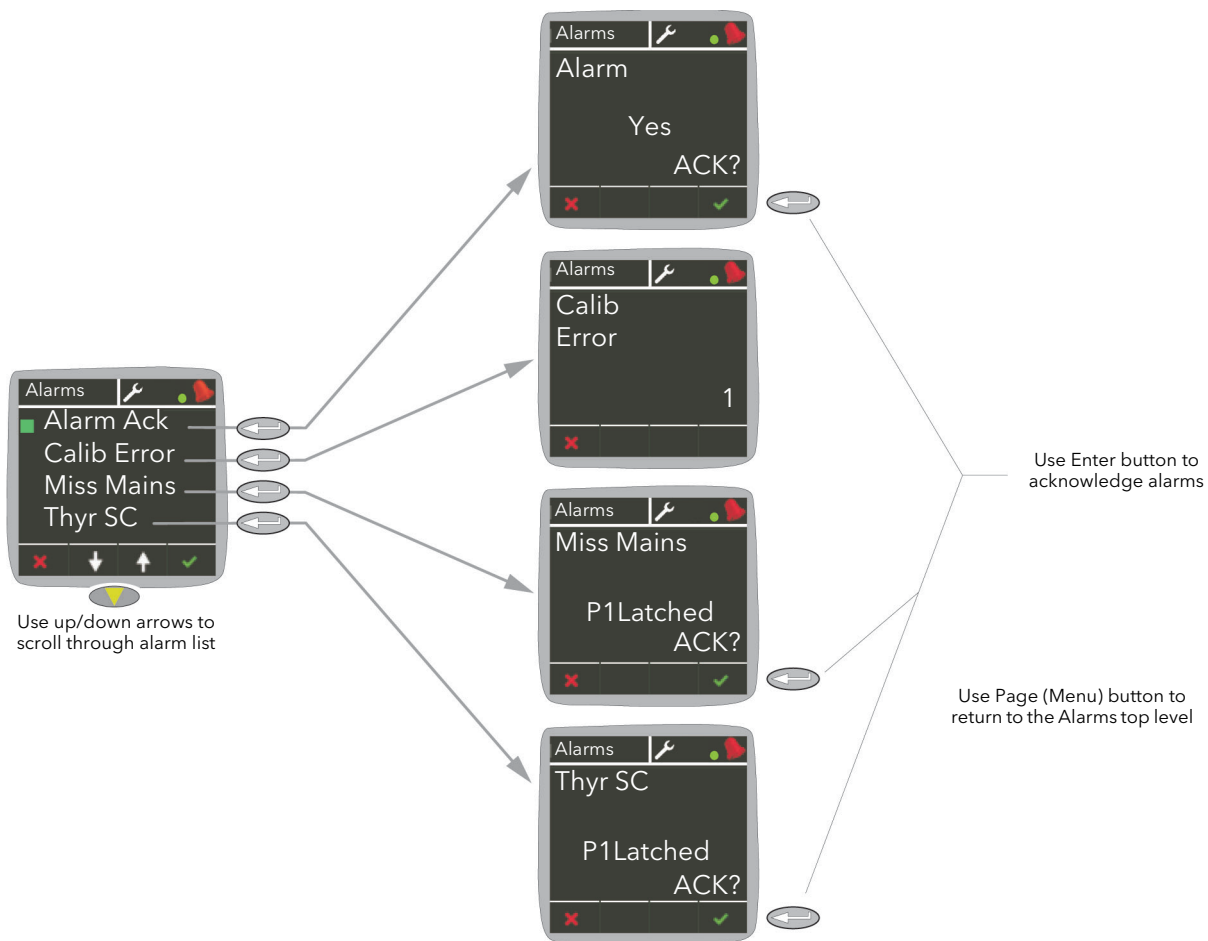

Figure 28 Alarms menu

## Alm Disable menu

This menu allows the user to disable particular alarm types, so that they are no longer detected or acted upon.

By default all of the alarms are enabled.

To disable or re-enable an alarm, simply scroll through the list and select the alarm you want, then use the arrow keys to toggle its status between Disable and Enable as required.

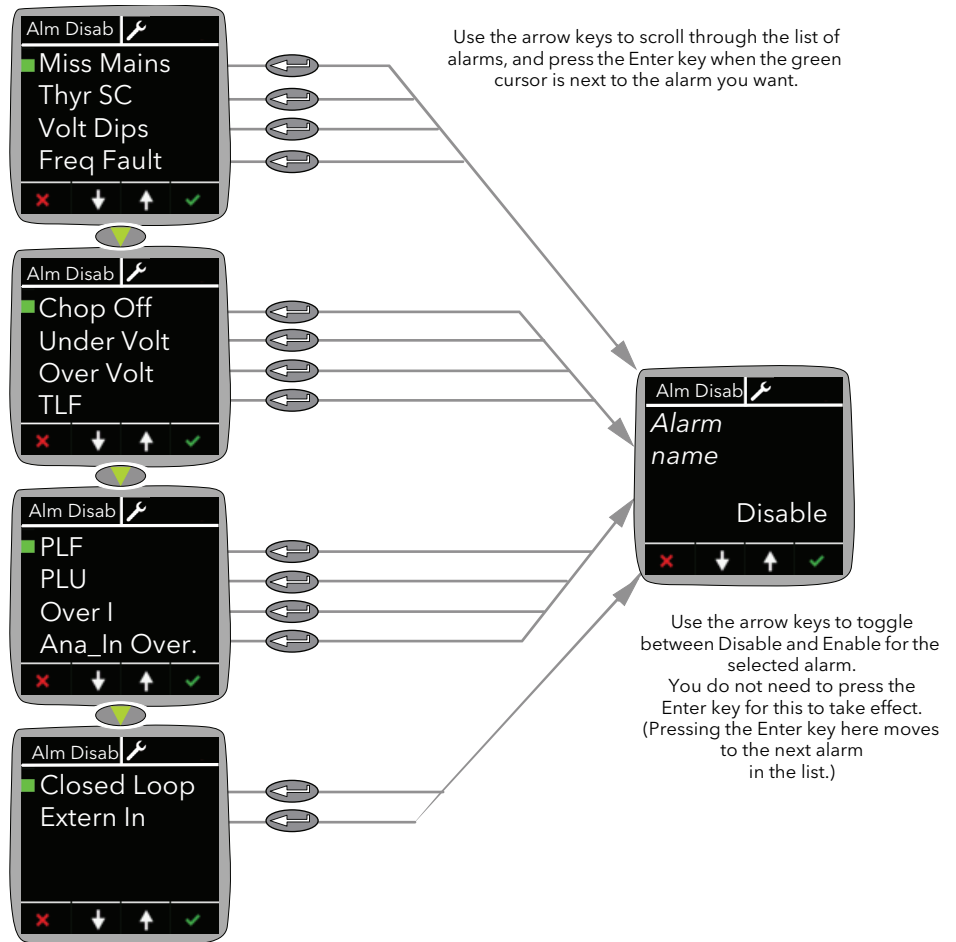

Figure 29 Alarm Disable menu



## Alm Latch Menu

This menu allows the user to set latching or no latching to particular alarm types.

To select the latching type, simply scroll through the list and select the alarm you want, then use the arrow keys to toggle its status between Latch and NoLatch as required.

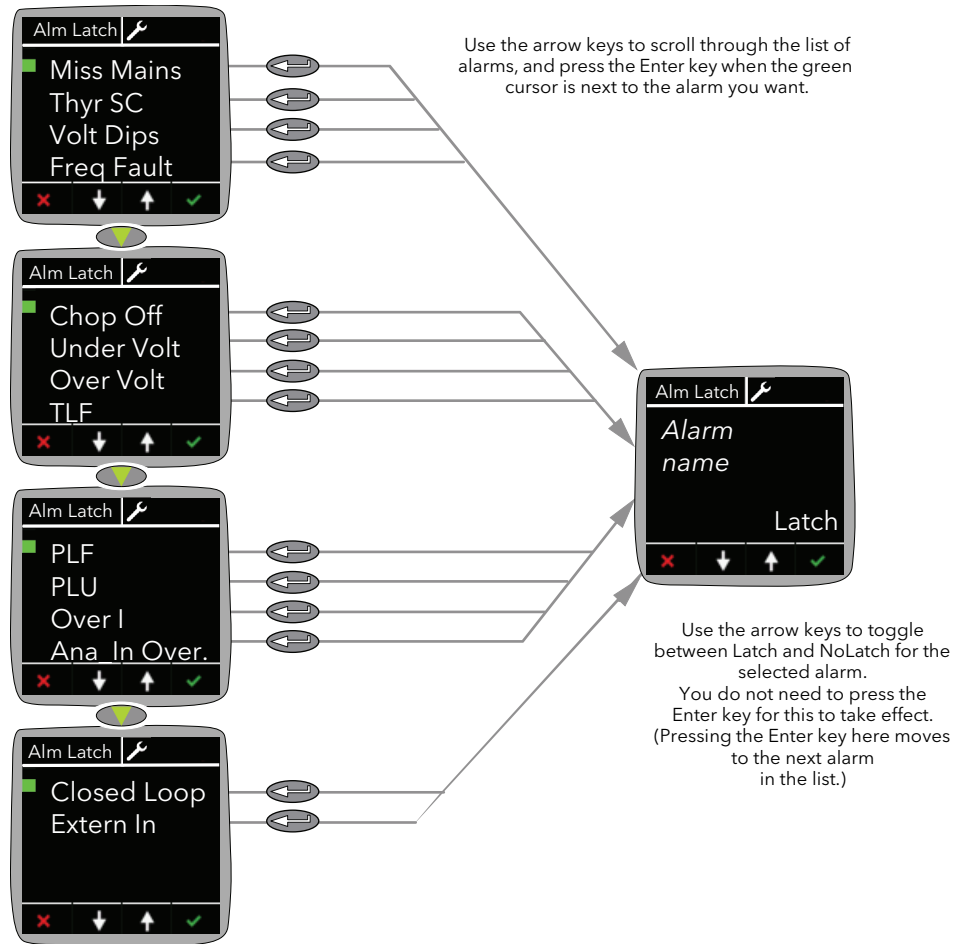

Figure 30 Alarm Latch Menu

## Alm Stop menu

This menu allows the user to set which alarms will cause the EPack Lite to stop firing. By default, none of the alarms are set to stop firing.

To change whether an alarm causes the EPack Lite to stop firing, simply scroll through the list and select the alarm you want, then use the arrow keys to toggle its status between Stop and NoStop as required.

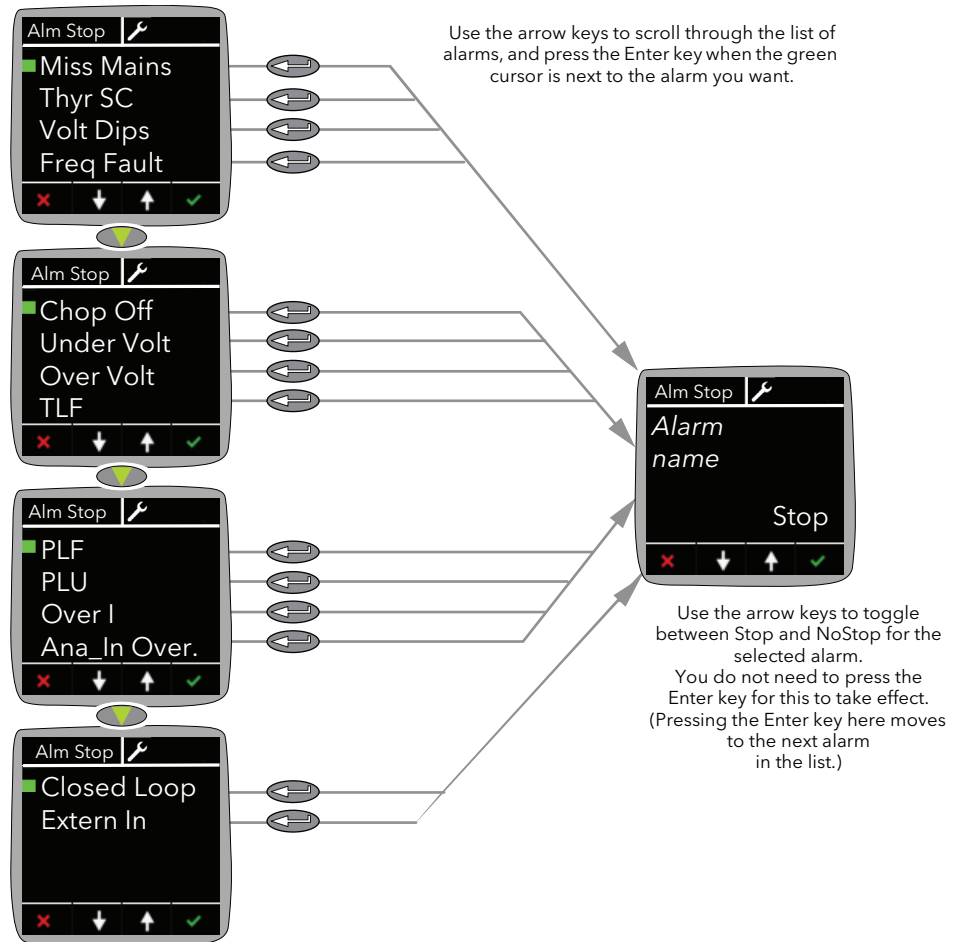

Figure 31 Alarm Stop menu

## Alm Relay menu

This menu allows the user to select which alarms are to operate (de-energize) the EPack Lite's 'watchdog' relay. For each selected alarm, select 'Yes' or 'No'.

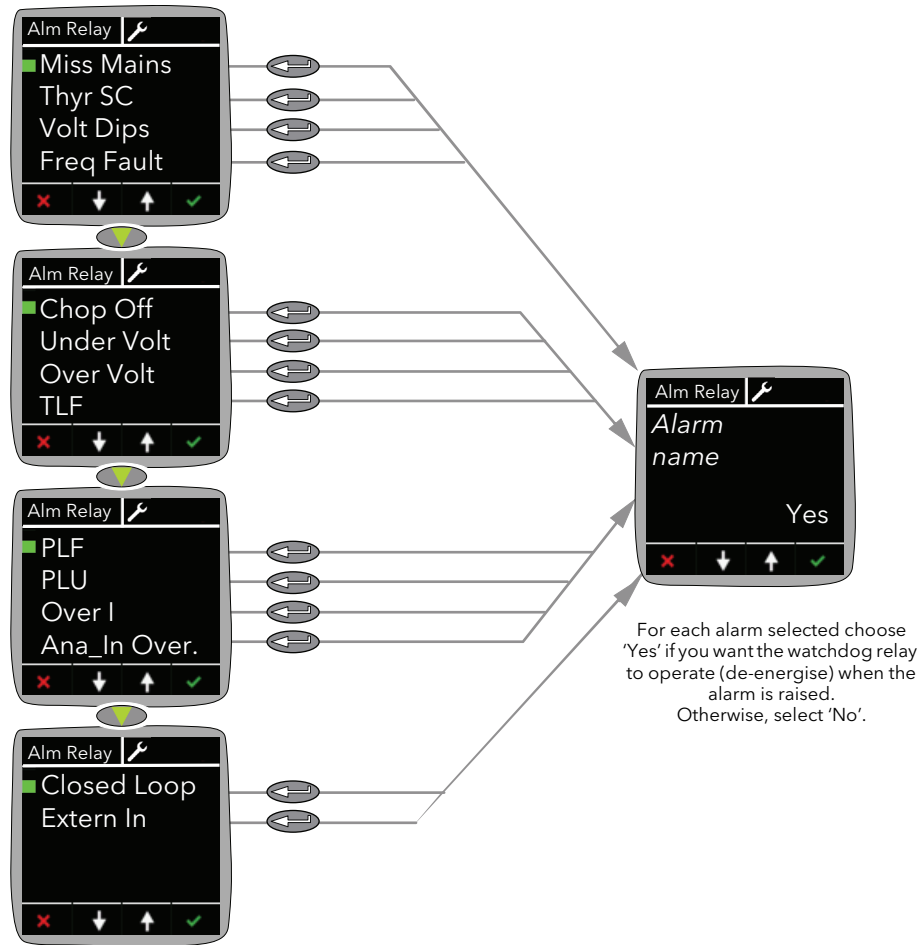

Figure 32 Alarm Relay menu

## DI Stat menu

The DI Stat menu displays the status of the EPack Lite's two digital inputs, DI1 and DI2.

'0' means a low level logic signal is being received at the input, '1' means a high level logic signal is being received at the input.

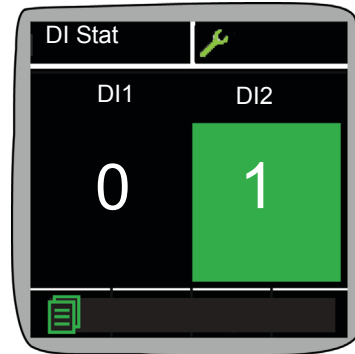

Figure 33 DI Stat menu

## PLF Adjust menu

See "Adjust menu" on page 66.

## Settings menu

The Settings menu is only available in Engineer mode. This menu is read-only, and lets you view the values of the parameters described below.

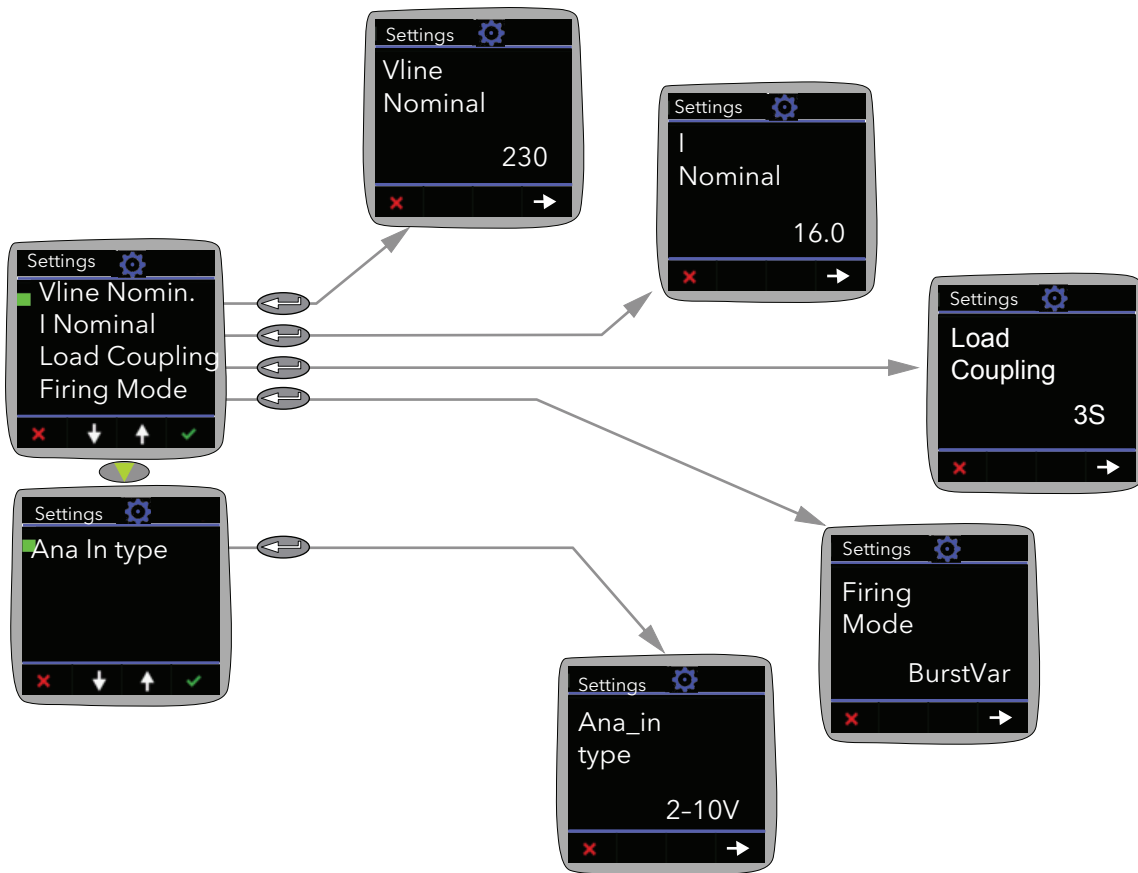

Figure 34 Settings menu

Vline Nominal	Line voltage nominal value (Line to neutral) or Line to L2 (phase to phase connection).Line voltage nominal value (Line to line for all listed configurations, except Star with Neutral (4S) which is Line to neutral), see <a href="#">Load Configurations (page 44)</a> .
I Nominal	Nominal current supplied to the load.
Load Coupling	Displays the current load configuration type. For diagrams of these configurations, see <a href="#">Load Configurations (page 44)</a> .
Firing Mode	Reports the firing mode: Burst Var, Burst Fix, Logic, Phase Angle (PA) or Intelligent half cycle (IHC).
Ana_in type	Reports the Analog Input type: 0 to 10V, 1 to 5 V, 2 to 10V, 0 to 5V, 0 to 20mA, or 4 to 20mA.

## Access menu

Allows access to the Operator, Engineer, Configuration, and Quick Code menus and allows passwords to be set up.

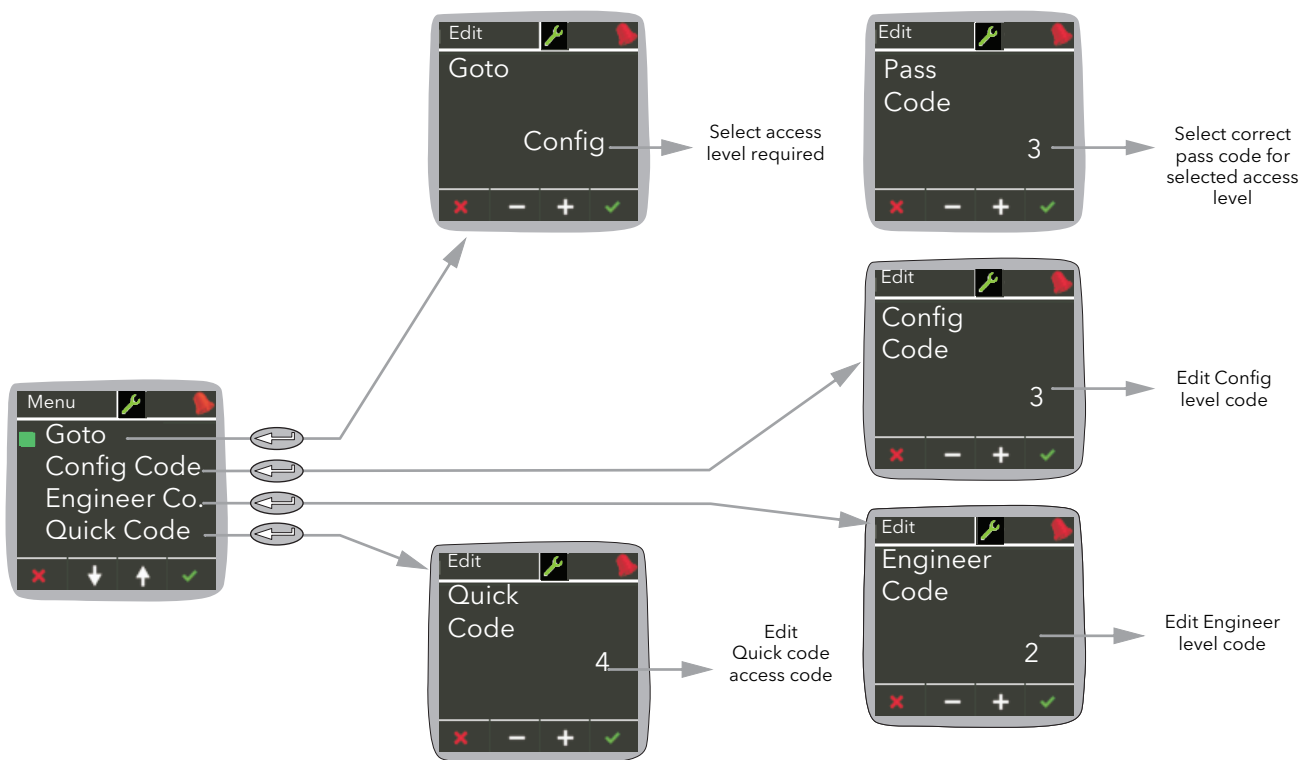

Figure 35 Access menu

**Note:** The default access codes are Operator = 0, Engineer = 2, Config = 3, Quickcode = 4.



# Alarms

## DANGER

### HAZARD OF ELECTRICAL SHOCK, EXPLOSION OR ARC FLASH

- Use appropriate safety interlocks where personnel and/or equipment hazards exist.

**Failure to follow these instructions will result in death or serious injury.**

EPack Lite alarms protect thyristors and loads against abnormal operation, and provide the user with valuable information regarding the type of fault.

Under no circumstances must these alarms be regarded as a replacement for proper personnel protection.

## Global System Monitoring

At power-up and in running for some functionalities EPack Lite performs a check of most of electronic parts (power supply, digital memory, and so on). In case of failure, EPack Lite reports a status in the Global Status Parameters available using communication and displays a message on its front fascia.

There are four types of message described below:

- The first one is related to a detected failure on displays microcontroller board and EPack Lite displays 'CONFIG ERROR'. For this kind of problem it is recommended to send the unit back to a repair center. EPack Lite also displays a code in hexadecimal for a technician. This code is also available in decimal through iTools in Global Status 0.
- The second one reports issues related to a hardware problem detected by the microcontroller. Issues can be located on the different boards. In this situation EPack Lite displays 'HW Problem'. For this kind of problem it is recommended to send the unit back to a repair center or contact your local representative. EPack Lite also displays a code in hexadecimal for a technician. This code is also available in decimal through iTools in Global Status 1.
- The third one is more related to configuration data set on production line, or during upgrade. In this case EPack Lite displays 'INVALID DATA'. For this kind of problem it is recommended to send the unit back to a repair center. EPack Lite also displays a code in hexadecimal for a technician. This code is also available in decimal through iTools in Global Status 2.
- The fourth one concerns detection of an internal malfunction mainly on the display microcontroller board. For this event EPack Lite displays 'INTERNAL FAILURE'. For this kind of problem it is recommended to send the unit back to a repair center. EPack Lite also displays a code in hexadecimal for a technician. This code is also available in decimal through iTools in Global Status 3.



## System Alarms

System alarms are considered to be 'Major Events' which help prevent proper operation of the system, and the unit is placed in standby mode.

The following subsections describe each of the possible system alarms.

### Missing mains

Supply power is missing.

### Thyristor short circuit

A thyristor short circuit leads to current flow even when not firing.

### Over temperature

Reserved for future development.

### Network dips

This detects a reduction in supply voltage, and if this reduction exceeds a configurable measured value (VdipsThreshold), firing will be inhibited until the supply voltage returns to a suitable value. VdipsThreshold represents a percentage change in supply voltage between successive half cycles and is set to 20% of Vline Nominal.

### Mains frequency fault detected

Triggered if the supply voltage frequency strays out of the range 47 to 63Hz, or if the mains frequency changes, for one cycle to the next, by more than the threshold defined in the Network

The threshold value is set to 5%.

### Chop Off alarm

Chop-off alarm will be active when a current threshold is exceeded for more than a pre-defined number of mains periods. This current threshold is set to 120%.

## Process Alarms

Process Alarms are related to the application and can be configured either to stop the unit firing (Standby Mode) or to allow operation to continue. Process alarms can also be configured to be latched and if so, they have to be acknowledged before the alarm is considered to be non-active. Alarms cannot be acknowledged until the trigger source has returned to a non-active state.

### Total Load Failure (TLF)

No load is connected.

### Closed Loop alarm

Closed loop break alarm is currently active.

### Alarm input

The alarm input associated with the alarm block is active.

### Over current detection

The analog input over current detection alarm is active.

### Over Voltage Alarm

A threshold to monitor an over-voltage is set to 10% of Vline Nominal. If exceeded, the OverVoltage alarm is set.

**Note:** This Alarm is returned FALSE if the MissingMains Alarm is set.

### Under Voltage Alarm

The threshold to monitor the under-voltage is set to 25% of Vline Nominal. If the VLine voltage falls below this threshold the UnderVoltage alarm is set.

**Note:** This Alarm is returned FALSE if the MissingMains Alarm is set.

## Partial Load Failure (PLF)

This alarm detects a static increase in load impedance by comparing the reference load impedance (as configured by the user) with the actual measured load impedance over a mains cycle (for phase angle firing) and over the burst period (for burst and logic firing).

Non-inductive loads, for example resistance furnaces, resistive loads with low temperature coefficient or short wave infrared loads can be monitored using this function. For other load types, for example AC51 slightly inductive loads or AC56a primary of transformer, please consult Eurotherm.

The sensitivity of the partial load failure measurement can be set to any value between 2 to 6 inclusive, where an entry of 2, for example, means that one half of the elements (or more) must be open circuit in order to trigger the alarm; an entry of 3 means that one third of the elements (or more) must be open circuit in order to trigger the alarm, and so on down to one sixth. All elements must have identical characteristics and identical impedance values and must be connected in parallel).

The relevant parameters (PLFAdjustReq, and PLFSensitivity) are both to be found in the as described in the section "Configuration from the Front Panel" on page 63.

## Indication Alarms

Indication Alarms signal events for operator action if required. Indication alarms cannot be configured to stop power module firing, but they may be latched if required, and if latched, they must be acknowledged for the Signalling Status to return to the normal (non-alarm) state.

## Load Over-Current

Indicates when a configurable RMS load current threshold (Overlthreshold) is reached or exceeded. This threshold is set to 120% of the nominal current.



# Maintenance

## Precautions

### DANGER

#### HAZARD OF ELECTRICAL SHOCK, EXPLOSION OR ARC FLASH

- Apply appropriate personal protective equipment (PPE) and follow safe electrical work practices. See applicable national standards e.g. NFPA70E, CSA Z462, BS 7671, NFC 18-510.
- This equipment must only be installed and serviced by qualified electrical personnel.
- Refer to manual for installation and servicing.
- The product is not suitable for isolation applications, within the meaning of EN60947-1 Turn off all power supplying this equipment before working on the loads of the equipment.
- Turn off all power supplying this equipment before working on equipment.
- Always use a properly rated voltage sensing device to confirm power is off.
- Do not disassemble, repair or modify the equipment. Contact your supplier for repair.
- This product must be installed, connected and used in compliance with prevailing standards and/or installation regulations.

**Failure to follow these instructions will result in death or serious injury.**

## Reasonable use and responsibility

The information contained in this manual is subject to change without notice. While every effort has been made to ensure the accuracy of the information, your supplier shall not be held liable for errors contained herein.

EPack Lite is an “AC semiconductor controllers for non-motor loads” designed according to IEC60947-4-3 & UL60947-4-1, it meets the requirements of the Low voltage and EMC European Directives which covers safety and EMC aspects.

Use in other applications, or failure to observe the installation instructions of this manual may impair safety or EMC.

The safety and EMC of any system incorporating this product is the responsibility of the assembler/installer of the system.

Failure to use approved software/hardware with our hardware products may result in injury, harm, or improper operating results.

Eurotherm shall not be held responsible for any damage, injury, losses or expenses caused by inappropriate use of the product (EPack Lite), or failure to comply with these instructions.

Under some circumstances, the EPack Lite heatsink temperature may rise by more than 50°C and it can take up to 15 minutes to cool after the product is shut down.

 <b>CAUTION</b>
<p><b>HOT SURFACE RISK OF BURNS</b></p> <ul style="list-style-type: none"> <li>• Allow heatsink to cool before servicing.</li> <li>• Do not allow flammable or heat-sensitive parts in the immediate vicinity of heatsink.</li> </ul> <p><b>Failure to follow these instructions can result in injury or equipment damage.</b></p>

## Preventive Maintenance

 <b>DANGER</b>
<p><b>HAZARD OF ELECTRICAL SHOCK, EXPLOSION OR ARC FLASH</b></p> <ul style="list-style-type: none"> <li>• Tighten all connections in conformance with the torque specifications. Periodic inspections are required.</li> </ul> <p><b>Failure to follow these instructions will result in death or serious injury.</b></p>

See Table 1, “Connection Details” on page 35.

Wires are not properly retained in terminals with insufficient torque.

Insufficient torque may increase the contact resistance:

- The protective earth ground connection may be too resistive. In case of short circuit between live parts and heatsink, the heatsink may reach a dangerous voltage.
- The power terminals will overheat.

Excessive torque may damage the terminal.

 <b>DANGER</b>
<p><b>HAZARD OF ELECTRICAL SHOCK, EXPLOSION OR ARC FLASH</b></p> <ul style="list-style-type: none"> <li>• Do not allow anything to fall through the case apertures and ingress the product.</li> </ul> <p><b>Failure to follow these instructions will result in death or serious injury.</b></p>

Conductive or non-conductive parts which ingress product may reduce or short the insulations barriers inside the product.

 <b>DANGER</b>
<p><b>HAZARD OF FIRE</b></p> <ul style="list-style-type: none"> <li>• Heat-sink must be cleaned regularly. Periodicity depends on the local environment, but should not exceed 1 year.</li> </ul> <p><b>Failure to follow these instructions will result in death or serious injury.</b></p>

## Fusing

### DANGER

#### HAZARD OF FIRE

- This product does not contain any branch-circuit protection, the installer must add branch-circuit protection upstream of the unit.
- Branch circuit protection must be selected according to maximum current in each phase and must be rated in compliance with local and national regulatory requirements.

**Failure to follow these instructions will result in death or serious injury.**

Branch circuit protection are mandatory to protect the wiring.

- CE: branch-circuit protection must be selected according to IEC 60364-4-43 or applicable local regulations.
- UL: branch-circuit protection must be selected according to NEC article 210.20, it is necessary for compliance with National Electric Code(NEC) requirements.

### DANGER

#### HAZARD OF ELECTRICAL SHOCK, EXPLOSION OR ARC FLASH

- High speed fuses (supplemental fuses in addition to branch circuit protective device), as listed in fusing sections, are mandatory to protect EPack Lite against load short circuit.
- If opening of either the branch circuit protective device or the high-speed fuses (supplemental fuses) occurs, the product must be examined by suitably qualified personnel and replaced if damaged.

**Failure to follow these instructions will result in death or serious injury.**

The power circuit must be protected by a supplementary fuse, which should be used in conjunction with suitable fuse holders (and contact kits, if required) as shown in Table 3 or Table 4.

**Note:** With a supplementary fuse (high speed fuse), EPack is suitable for use on a circuit capable of delivering not more than 100kA RMS symmetrical amperes, 500 Volts Maximum (coordination Type 2)

### Coordination Type 1 and Type 2 explanations

**Type 1:** Type 1 coordination requires that, under short-circuit conditions, the device must cause no danger to persons or to the installation but may not be suitable for further service without repair and replacement of parts.

**Type 2:** Type 2 coordination requires that, under short-circuit conditions, the device must cause no danger to persons or to the installation and must be suitable for further use.

Table 3: Details of high-speed fuses (WITHOUT microswitch) and fuse holders required for EPack with order code HSP

EPack current rating	Fuse rating	Fuse manufacturer & catalog number	Qty	Fuse body size (mm)	Fuse holder		Contact kit
					Manufacturer & catalog number	Qty	Qty
≤25A	30A or 32A	Mersen FR10GR69V30 Mersen FR10GR69V32	3	10×38	Mersen US103 or Mersen CUS103	1	0
32A	40A	Mersen FR14GR69V40 Mersen FR14GC69V40 Cooper-Bussmann FWP-40A14F		14×51	Mersen US143		
40A	50A	Mersen FR14UC69V50 Cooper-Bussmann FWP-50A14F					
50A	63A	Mersen FR22UD69V63					
63A	80A	Mersen FR22GC69V80 Cooper Bussmann FWP-80A22F		22×58	Mersen US223		
80A to 125A	200A	Mersen FR27UQ69V200T		27×60	Mersen US273		



Table 4: Details of high-speed fuses (WITH microswitch) and fuse holders required for EPack with order code HSM

EPack current rating	Fuse rating	Fuse manufacturer & catalog number	Qty	Fuse body size (mm)	Fuse holder		Contact kit	
					Manufacturer & catalog number	Qty	Manufacturer & catalog number	Qty
≤25A	32A	Mersen FR14GR69V32T Mersen FR14GC69V32T Cooper-Bussmann FWP-32A14FI	3	14×51	Mersen US143	1	Mersen Y227928A	3
32A	40A	Mersen FR14GR69V40T Mersen FR14GC69V40T Cooper-Bussmann FWP-40A14FI						
40A	50A	Mersen FR14UD69V50T Cooper-Bussmann FWP-50A14FI						
50A	63A	Mersen FR22UD69V63T		22×58	Mersen US223		Mersen G227959A	
63A	80A	Mersen FR22GC69V80T Cooper-Bussmann FWP-80A22FI						
80A & 125A	200A	Mersen FR27UQ69V200T						

## DANGER

### HAZARD OF ELECTRICAL SHOCK, EXPLOSION OR ARC FLASH

- Tighten all connections in conformance with the torque specifications. Periodic inspections are required.

**Failure to follow these instructions will result in death or serious injury.**

Unless otherwise mentioned on the side of the fuse holders, torque fuse holders terminals at 2Nm.

Wires are not properly retained in terminals with insufficient torque. Insufficient torque may increase the contact resistance, causing the power terminals to overheat.

Excessive torque may damage the terminal.

## Fuses Holders Contacts Kit

For technical specification and recommended wiring, see "Fuse Holders Contact Data (Fuse Ordering Code HSM)" on page 50.

## Fuse holder dimensions

Figures 36 to 40 show dimensional details for the various fuse holders listed in Table 3 and Table 4 (not all shown to the same scale).

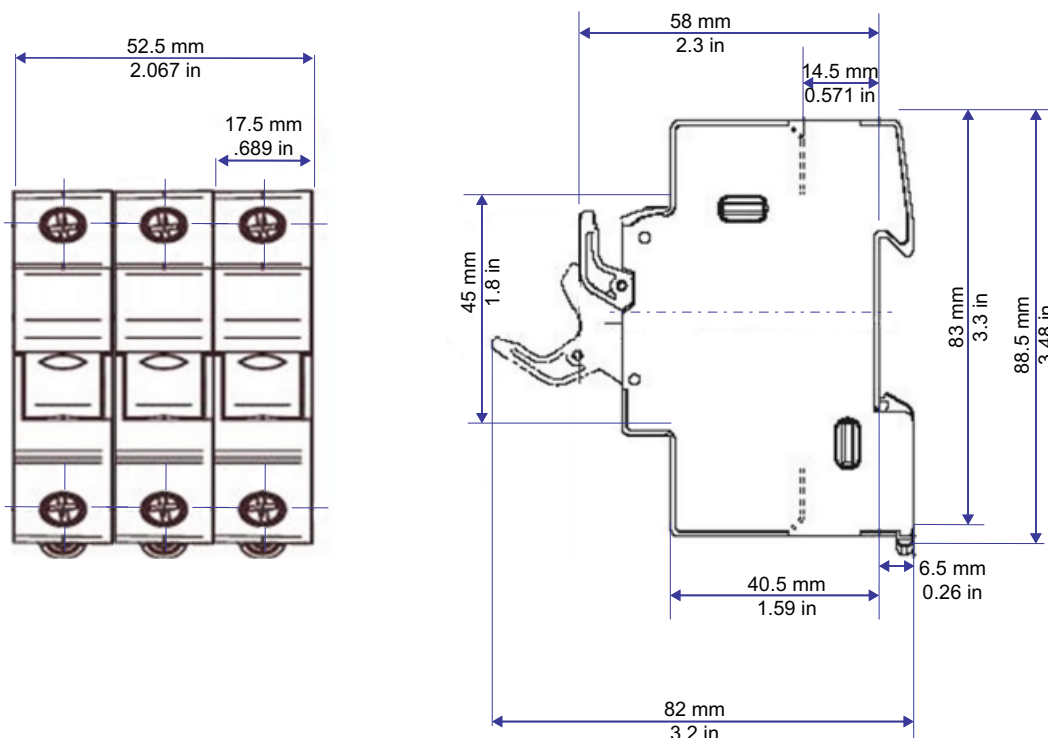

Figure 36 Fuse holder dimensions: US103 (10x38mm)

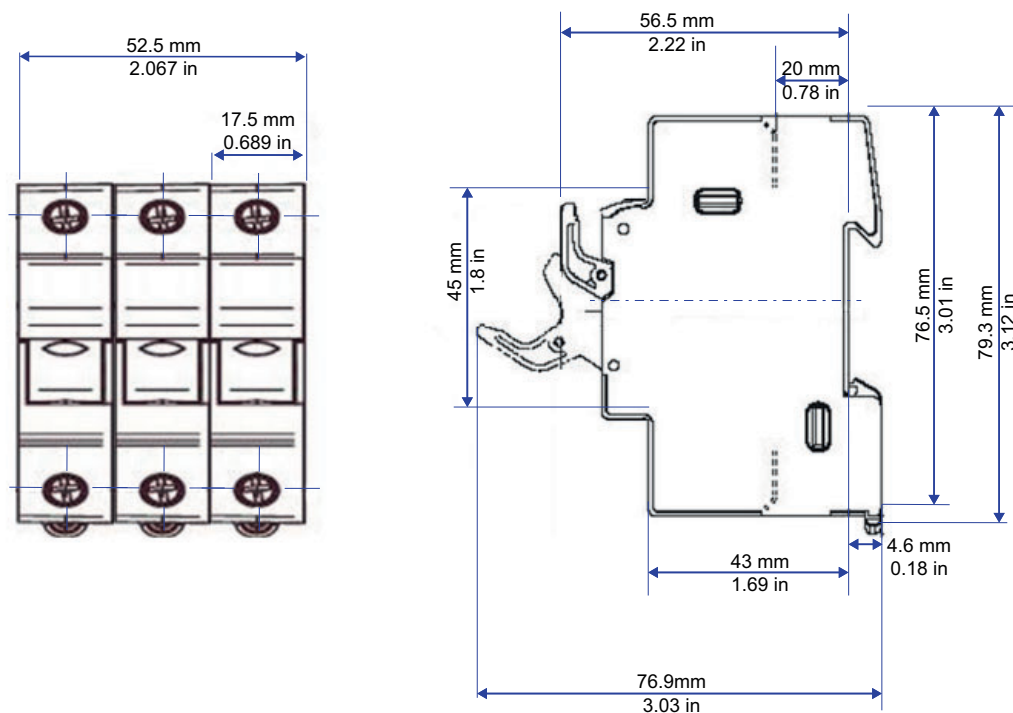

Figure 37 Fuse holder dimensions: CUS103 (10x38mm)

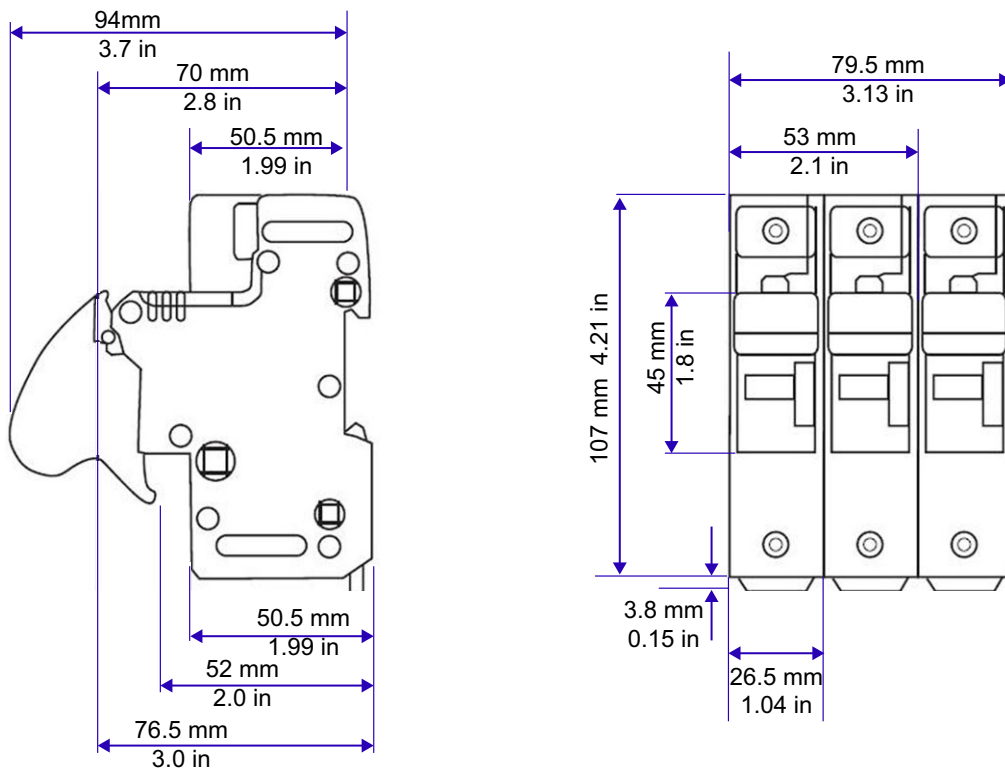

Figure 38 Fuse holder dimensions: US143 (14x51mm)

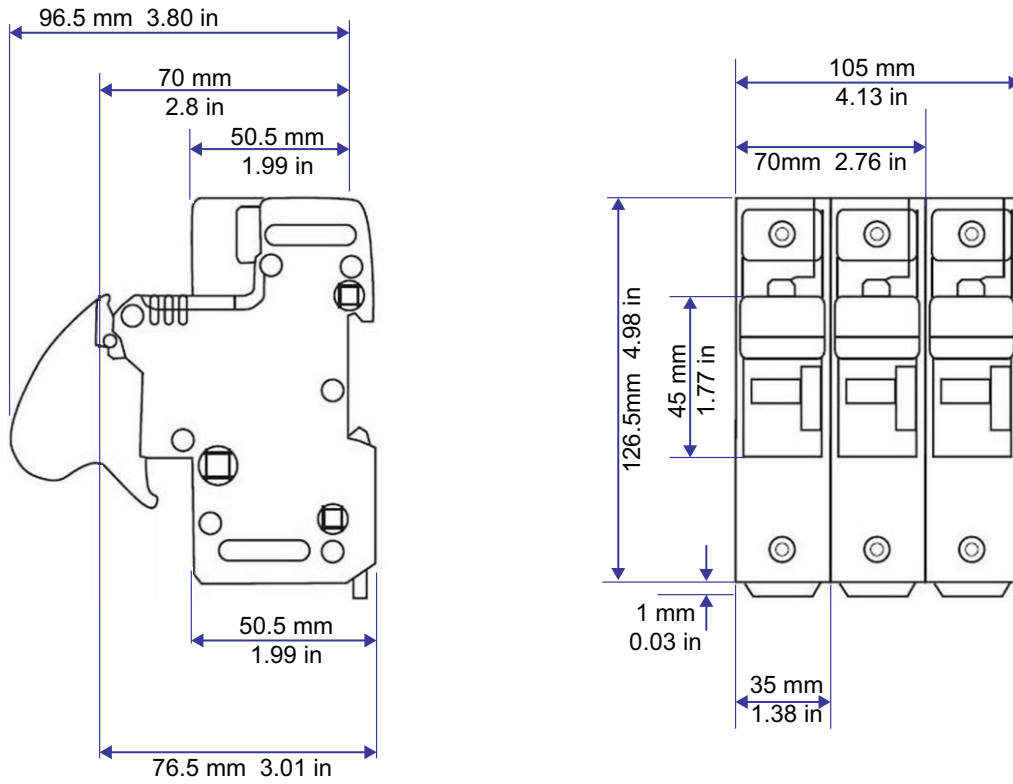

Figure 39 Fuse holder dimensions: US223 (22x58mm)

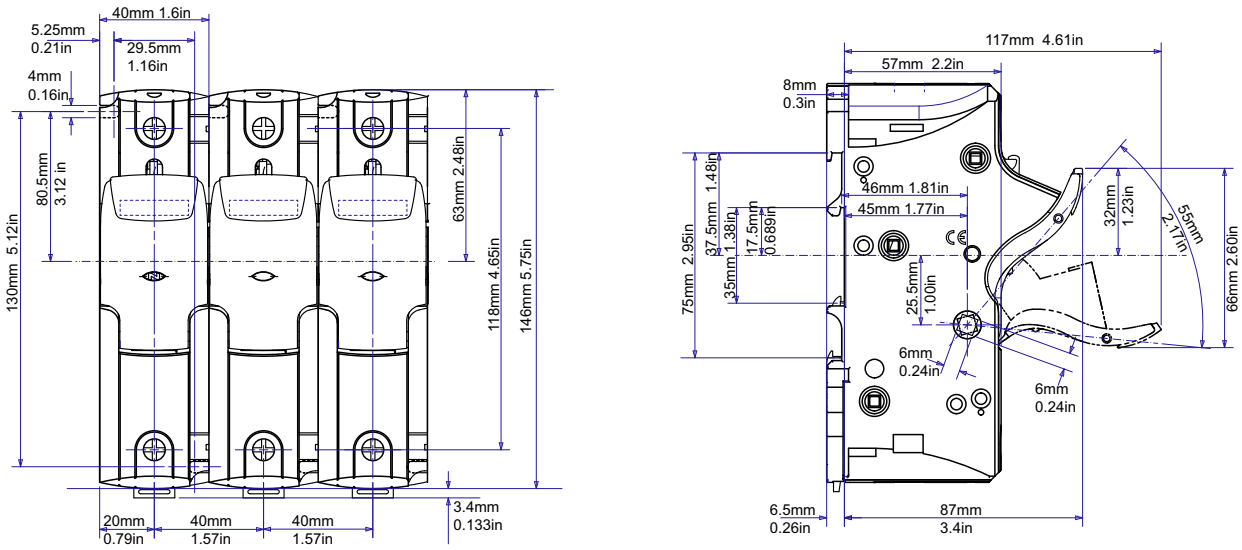



Figure 40 Fuse holder dimensions: US273 (27x60mm)

## Auxiliary supply fuse protection

 <b>DANGER</b>
<p><b>HAZARD OF FIRE</b></p> <ul style="list-style-type: none"> <li>The cables used to connect the EPack Lite’s auxiliary supply and voltage reference must be protected by branch-circuit protection. Such branch-circuit protection must comply with local and national regulatory requirements.</li> </ul> <p><b>Failure to follow these instructions will result in death or serious injury.</b></p>

Branch circuit protection is mandatory to protect the cable used to connect the auxiliary supply.

- CE: branch-circuit protection must be selected according to IEC 60364-4-43 or applicable local regulations.
- UL: branch-circuit protection must be selected according to NEC article 210.20, it is necessary for compliance with National Electric Code(NEC) requirements.

 <b>DANGER</b>
<p><b>HAZARD OF ELECTRICAL SHOCK, EXPLOSION OR ARC FLASH</b></p> <ul style="list-style-type: none"> <li>A High-speed fuse (supplemental fuses in addition to branch circuit protective device) or a double protection fuse as listed in fusing sections is mandatory for 85Vac to 550Vac auxiliary supply.</li> </ul> <p><b>Failure to follow these instructions will result in death or serious injury.</b></p>

This fuse is necessary to avoid the 85Vac to 550Vac auxiliary supply to emit flame or molten element in case of breakdown of a component.

High-speed fuse (supplemental fuse) does not protect the wiring they must be fitted in addition to branch circuit protective device).

Double protection fuse combines a branch circuit fuse and a high-speed fuse. Double protection fuse must be selected according to applicable national standards. Branch circuit protection fuses Standard in USA/Canada differ from IEC standards (e.g; Europe (CE)). Therefore:

- A fuse approved as branch circuit protection fuses in USA/Canada is not a branch circuit in all countries where IEC standards apply (e.g; Europe (CE)).
- A fuse approved as branch circuit protection fuses in all countries where IEC standards apply (e.g; Europe (CE)) is not a branch circuit in USA/Canada.

Table 5: Auxiliary supply fuse protection

UL Fuse Category	CE Fuse Category	Fuse (Make and Type)
Supplemental	Supplemental	ATM2-type fuse rated 2A, 600Vac/dc: Mersen/Ferraz Shawmut (UL file: E33925)
Branch Circuit	Supplemental	J-type fuse rated 3A/600Vac: HSJ3 by Mersen/Ferraz Shawmut (UL file: E2137; CSA class: 1422-02 LR12636) or DFJ-3 by Eaton/Cooper Bussman (UL file: E4273; CSA class: 1422-02 LR53787)
Supplemental	Branch Circuit	gR-type fuses rated 3A /700V: FR10GR69V3 (V1014571) by Mersen/Ferraz Shawmut (UL file: E76491)

 **DANGER**
**HAZARD OF ELECTRICAL SHOCK, EXPLOSION OR ARC FLASH**

- If opening of any fuses or branch circuit protection device that supply the 85Vac to 550Vac auxiliary supply occurs, first check the wiring. If the wiring is not damaged, do not replace the fuse and contact the manufacturer's local service center.

**Failure to follow these instructions will result in death or serious injury.**

If the wiring is not damaged a component inside the 85Vac to 550Vac auxiliary supply is broken and product must go back to service center.

## Instrument upgrade

Contact your local representative.

## Software upgrade

Software upgrade can be carried out by following the section below.

### Obtaining a Passcode via Telephone

1. Telephone the local Eurotherm Sales/Service agent with the serial number of the instrument to be updated, and the current software version. This information can be found in the Info sub-menu whilst in Configuration mode from the front panel. Refer to "Info menu" on page 70.
2. Place an order for the required new functionality.
3. A new passcode will be provided which is to be entered in the Info menu available from the front panel whilst in Configuration mode.

## EPack Licence Notice

FreeRTOS

EPack is powered by an original FreeRTOS from version v7.1.0.

FreeRTOS is available at <http://www.freertos.org>







# Technical Specification

## Standards

The product is designed and produced to comply with:

Countries	Standard symbol	Standard details
European community		EN60947-4-3:2014. Low-voltage switchgear and controlgear - Part 4-3: Contactors and motor-starters - AC semiconductor controllers and contactors for non-motor loads (identical to IEC60947-4-3:2014). Declaration of conformity available on request.
USA & Canada		UL60947-4-1 CAN/CSA C22.2 NO.60947-4-1-14 Low-Voltage Switchgear and Controlgear - Part 4-1: Contactors and Motor-Starters - Electromechanical Contactors and Motor-Starters U.L. File N° E86160
Australia		Regulatory Compliance Mark (RCM) to Australian Communication and Media Authority. Based on compliance to EN60947-4-3:2014.
China	/	Product not listed in catalog of products subject to China Compulsory Certification (CCC)

## Installation Categories

**DANGER**

**HAZARD OF ELECTRICAL SHOCK, EXPLOSION OR ARC FLASH**

- Do not exceed the device's ratings.

**Failure to follow these instructions will result in death or serious injury.**

The insulation barriers of the equipment have been designed for the rating as defined in the table below at an altitude of 2000m maximum.

Table 6: Installation categories

	Installation Category	Rated impulse withstand voltage (Uimp)	Rated insulation voltage	Maximum value of rated operational voltage to earth
Communications	II	0.5kV	50V	50V
Standard IO	II	0.5kV	50V	50V
Relays	III	4kV	300V	300V
Power terminals	III	6kV	500V	500V

## Specification

### Power (at 45°C)

Voltage range

Load: 100 to 500V (+10% -15%)  
 Auxiliary: 24V ac/dc (+20% -20%)  
 or  
 100 to 500V (+10% -15%)

**DANGER**

**HAZARD OF ELECTRICAL SHOCK, EXPLOSION OR ARC FLASH**

- The maximum voltage between any pole of the 85Vac to 550Vac auxiliary supply and all other terminals must be lower than 550Vac.

**Failure to follow these instructions will result in death or serious injury.**

If the 85Vac to 550Vac auxiliary supply is supplied by a dedicated transformer the phasing must be checked to avoid overvoltage.

**DANGER**

**HAZARD OF ELECTRICAL SHOCK, EXPLOSION OR ARC FLASH**

- The "24V auxiliary supply" is an SELV circuit. The supply voltage must be derived from a SELV or PELV circuit.

**Failure to follow these instructions will result in death or serious injury.**

SELV is defined (in IEC60947-1) as an electrical circuit in which the voltage cannot exceed 'ELV' under normal conditions or under single fault conditions, including earth ground faults in other circuits.

The definition of ELV is complex as it depends on environment, signal frequency, etc. See IEC 61140 for further details.

Frequency range	47 to 63Hz for line and ac auxiliary supplies
Power requirement:	
	24V dc 12W
	24V ac 18VA
	500V ac 20VA
Installation category	See <a href="#">Table 6</a> above.
Nominal load current	16 to 125 Amps
Power Dissipation	1.3 Watts per amp, per phase
Pollution degree	Pollution degree 2

**DANGER**

**HAZARD OF ELECTRICAL SHOCK, EXPLOSION OR ARC FLASH**

- Electrically conductive pollution must be excluded from the cabinet in which the product is mounted.

**Failure to follow these instructions will result in death or serious injury.**

The product has been designed for pollution degree 2 according to IEC60947-1 definition: Normally, only non-conductive pollution occurs. Occasionally, however, a temporary conductivity caused by condensation may be expected.

Electrically conductive pollution must be excluded from the cabinet in which the product is mounted. To ensure a suitable atmosphere in conditions of conductive pollution, fit adequate air conditioning/filtering/cooling equipment to the air intake of the cabinet, e.g. fitting fan-cooled cabinets with a fan failure detection device or a thermal safety cut-out.

Duty cycle	Uninterrupted duty / continuous operation
Device form designation	Form 4 (Semiconductor controller)
Short circuit protection	By external supplemental fuses (high speed fuse) - see "Fusing" on page 87.
Rated conditional short-circuit current	100kA (Coordination Type 2)
Utilization categories	AC51: Non-inductive or slightly inductive loads, resistance furnaces AC56a: Transformer Primary
Heater Type	Low/high temperature coefficient and non-aging/aging types: MOSI Molybdenum Silicide, Silicon Carbide, Carbon.
Overload conditions	AC51: 1xle continuous
Load Power factor	0.85 for Loads from 32A up to 125A

**DANGER**

**HAZARD OF ELECTRICAL SHOCK, EXPLOSION OR ARC FLASH**

- Do not exceed the device's ratings.

**Failure to follow these instructions will result in death or serious injury.**

Only SLIGHTLY inductive loads are allowed, contact Eurotherm for advice for Loads lower than 32A.

## Physical

Dimensions and mounting centers	See Figure 4, Figure 5, Figure 6 and Figure 7 for details
Weight:	
16 to 32A units	3060g + user connectors
40 to 63A units	3510g + user connectors
80A and 100A units	5830g + user connectors
125 A units	7940g + user connectors

## Environment

Temperature limits:	
Operating:	0°C to 45°C at 1000m 0°C to 40°C at 2000m
Storage:	-25°C to +70°C
Altitude:	1000m maximum at 45°C 2000m maximum at 40°C

** DANGER**

**HAZARD OF ELECTRICAL SHOCK, EXPLOSION OR ARC FLASH**

- Do not exceed the device's ratings.

**Failure to follow these instructions will result in death or serious injury.**

The insulations barriers of the equipment have been designed for an altitude of 2000m maximum.

** DANGER**

**HAZARD OF FIRE**

- At commissioning ensure that under maximum load condition, the ambient temperature of the product will not exceed the limit stated in that manual.

**Failure to follow these instructions will result in death or serious injury.**

Humidity limits	5% to 95% RH (non-condensing)
Degree of Protection (CE)	
	All units: IP20 (EN60529)

** DANGER**

**HAZARD OF ELECTRICAL SHOCK, EXPLOSION OR ARC FLASH**

- Respect electrical installation requirements to ensure, improve the IP rating.

**Failure to follow these instructions will result in death or serious injury.**

If the conductor stripping lengths of the power cables are longer than the requirements IP20 is compromised.

If the conductor stripping lengths of the power cables are shorter than the requirements there is a potential risk of total loss of connection. Wires may slip out of the terminals.

If the breakaway features are removed for cables with diameter lower than 9mm the IP20 is compromised and the product is IP10.

<p>Enclosure type ratings (UL)                  All units:                  Atmosphere                  External wiring</p>	<p>Open type                  Non-explosive, non-corrosive, non-conductive</p>
	<p>IEC/CE: Must comply with IEC60364-1 and IEC60364-5-54 and all applicable local regulations.                  UL: Wiring must comply with NEC and all applicable local regulations. Cross sections must comply with NEC, Article 310 Table 310-16.(see <a href="#">Table 1</a> of this manual for temperature ratings)</p>
<p>Shock</p>	<p>According to EN60068-2-27 and IEC60947-1 (Annex Q, Category E)</p>
<p>Vibration</p>	<p>According to EN60068-2-6 and IEC60947-1 (Annex Q, Category E)</p>
<p>EMC Standard:</p>	<p>EN60947-4-3:2014.                  See <a href="#">Table 7</a> and <a href="#">Table 8</a> for EMC emission and immunity levels attained.</p>

Table 7: EMC immunity tests

<b>EMC immunity tests (According to EN60947-4-3:2014)</b>				
	Level		Criteria	
	Requested	Achieved	Requested	Achieved
Electrostatic discharge (test method of IEC 61000-4-2)	Air discharge mode 8kV Contact discharge mode 4kV	Air discharge mode 8kV Contact discharge mode 4kV	2	2
Radiated radio-frequency electromagnetic field test (test method of EN 61000-4-3)	10V/m from 80MHz to 1GHz and from 1.4GHz to 2GHz	15V/m from 80MHz to 3GHz	1	1
Fast transient/burst test (5/50 ns) (test method of EN 61000-4-4)	Power ports 2kV / 5kHz Signal ports 1kV / 5kHz	Power ports 4kV / 5 kHz Signal ports 4kV / 5 kHz	2	2
Surge Voltage test (1,2/50µs - 8/20µs) (test method of EN 61000-4-5)	2kV line to earth 1kV line to line	2kV line to earth 1kV line to line	2	2
Conducted radio-frequency test (test method of EN 61000-4-6)	10V (140dBµV) from 0.15MHz to 80 MHz	15V (143.5dBµV) from 0.15MHz to 80 MHz	1	1
Voltage dips test (test method of EN 61000-4-11)	0% during 0.5 cycle & 1 cycle	0% during 0.5 cycle & 1 cycle	2	2
	40% during 10/12 cycles	40% during 10/12 cycles	3	2
	70% during 25/30 cycles	70% during 25/30 cycles	3	2
	80% during 250/300 cycles	80% during 250/300 cycles	3	2
Short interruptions test (test method of EN 61000-4-11)	0% during 250/300 cycles	0% during 250/300 cycles	3	2

Table 8: EMC emission tests

EMC emission tests (According to EN60947-4-3:2014)				
Test	Frequency (MHz)	Limit level for class A industrial		Comments
		Quasi peak dB (µV)	Average dB (µV)	
Radiated radio frequency emission test According to EN60947-4-3:2014 (test method of CISPR11)	30 to 230	40 at 10m	N/A	Pass
	230 to 1000	47 at 10m	N/A	
Conducted radio frequency emission test According to EN 60947-4-3:2014 for rated power <20kVA (test method of CISPR11)	0.15 to 0.5	79	66	The conducted emissions can meet the requirement of IEC60947-4-3:2014 with an external filter added on the line connections.  This is in line with the rest of the industry <sup>2</sup>
	5 to 30	73	60	
Conducted radio frequency emission test According to EN 60947-4-3:2014 for rated power >20kVA (test method of CISPR11)	0.15 to 0.5	100	90	
	0.5 to 5	86	76	
	5 to 30	90 to 73 <sup>1</sup>	80 to 60 <sup>1</sup>	

1. Decrease with log of frequency emissions.
2. Technical note TN1618 (available upon customer request) describes the recommended filter structures which reduce conducted radio-frequency emissions.

**WARNING**

**UNINTENDED EQUIPMENT OPERATION**

- Do not use the product for critical control or protection applications where human or equipment safety relies on the operation of the control circuit.
- Signal and power voltage wiring must be kept separate from one another. Where this is impractical, all wires must be rated to the power voltage & shielded cables are recommended for signal wiring.
- This product has been designed for environment A (Industrial). Use of this product in environment B (domestic, commercial and light industrial) may cause unwanted electromagnetic disturbances in which cases the installer may be required to take adequate mitigation measures.
- For Electromagnetic Compatibility, the panel or DIN rail to which the product is attached must be grounded.
- Observe all electrostatic discharge precautions before handling the unit.
- Nominal current of product must be set between 25% & 100% of maximum current

**Failure to follow these instructions can result in death, serious injury or equipment damage.**

DANGER

**HAZARD OF ELECTRICAL SHOCK, EXPLOSION OR ARC FLASH**

- The I/O Input & Output, the Communications ports are SELV circuit. They must be connected to SELV or PELV circuit.
- The relay output and the fuse holders contacts are compliant to the SELV requirements; they can be connected to SELV, PELV circuit or to voltage up to 230V (maximum value of rated operational voltage to earth:230V)

**Failure to follow these instructions will result in death or serious injury.**

SELV is defined (in IEC60947-1) as an electrical circuit in which the voltage cannot exceed 'ELV' under normal conditions or under single fault conditions, including earth ground faults in other circuits.

The definition of ELV is complex as it depends on environment, signal frequency, etc. See IEC 61140 for further details.

### Operator Interface

Display	1.44" square TFT colour display allowing viewing of selected parameter values in real time, plus configuration of instrument parameters for users with adequate access permission.
Push buttons	Four push buttons provide page and item entry and scroll facilities.

### Inputs/Outputs

All figures are with respect to 0V, unless otherwise stated.

Number of inputs/outputs	1 Analog input; 2 Digital inputs (DI1 and DI2); 1 Relay output See <a href="#">I/O Input &amp; Output Details (page 49)</a>
Update rate	Twice the mains frequency. Defaults to 55Hz (18 ms) if the supply frequency lies outside the range 47 to 63Hz.)
Termination	Removable 5-way connector. Located as shown in <a href="#">Figure 14</a> .

**Analog Input**

Performance	See <a href="#">Table 9</a> and <a href="#">Table 10</a>
Input type	Configurable as one of: 0 to 10V, 1 to 5V, 2 to 10V, 0 to 5V, 0 to 20mA, 4 to 20mA
Absolute input maxima	-0.6V to +16V and ±40mA



Table 9: Analog input specification (voltage inputs)

Analog input: Voltage input performance		
Parameter	Typical	Max/Min
Total voltage working input span		0V to +10V
Resolution (electrical noise free) (note 1)	11 bits	
Calibration accuracy (notes 2, 3)	<0.1%	<0.1%
Linearity accuracy (note 2)		±0.1%
Ambient temperature deviation (note 3)		<0.01%/°C
Input resistance (terminal to 0V)	142kΩ	±0.2%

Note 1: w.r.t. total working span  
 Note 2: % of effective range (0 to 5V, 0 to 10V)  
 Note 3: After warm up. Ambient = 25 °C

Table 10: Analog input specification (current inputs)

Analog input: Current input performance		
Parameter	Typical	Max/Min
Total current working input span		0 to +25mA
Resolution (electrical noise free) (note 1)	11 bits	
Calibration accuracy (notes 2, 3)		<0.2%
Linearity accuracy (note 2)		±0.1%
Ambient temperature deviation (note 2)		±0.01%/°C
Input resistance (terminal to 0v)	<102Ω	±1%

Note 1: w.r.t. total working span  
 Note 2: % of effective range (0 to 20mA)  
 Note 3: After warm up. Ambient = 25 °C

## Digital Inputs

### Voltage inputs

Active level (high):  $11V < V_{in} < 30V$  with  $6mA < \text{input current} < 30mA$

Non-active level (low):  $-3V < V_{in} < 5V$  with  $2mA < \text{input current} < 30mA$

Or

$5V < V_{in} < 11V$  with input current  $< 2mA$

### Contact closure inputs

Source current: 10mA min - 15mA max

Open contact (non active)

resistance:  $> 800\Omega$

Closed contact (active)

resistance:  $< 450\Omega$

Absolute Maxima:  $\pm 30V$  or  $\pm 25mA$

**Note:** Absolute maximum ratings refer to externally applied signals

### Digital Output

User configured output (DI2):  $\pm 2\%$  10.2V, 10mA

For example; To supply a potentiometer between  $2k\Omega - 10k\Omega$  ( $\pm 20\%$ ) used to drive the Analog Input when set to Voltage mode - see [Inputs/Outputs \(page 104\)](#).

## Relay Specification

The relay has gold plated contacts suitable for 'dry circuit' (low current) use. See "I/O Input & Output Details" on page 49.

Contact life

Resistive loads: 100,000 operations

Inductive loads: Derate as per accompanying graph (Figure 41)

High power use

Current: 2A (resistive loads)

Voltage: <264V RMS (UL: voltage 250Vac.)

Low power use

Current: >10 mA

Voltage: >5V

Contact configuration:

Single pole change-over (one set of Common, Normally Open and Normally Closed contacts)

Termination

Removable 3-way connector. Located as shown in Figure 14.

Installation Category

Installation category III, assuming that nominal phase to earth ground voltage is  $\leq 300V$  RMS.

Absolute max. switching capability

<2A at 240V RMS (resistive loads)

**Note:** 'Normally Closed' and 'Normally Open' refer to the relay when the coil is not energized.

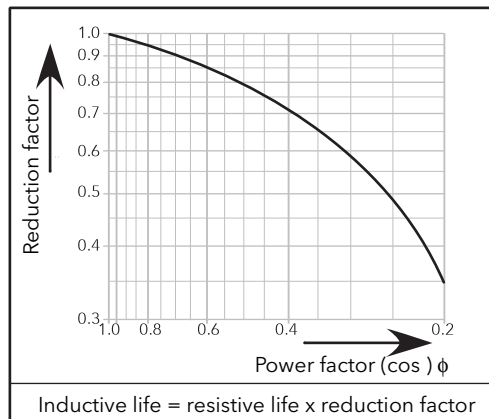

Figure 41 Relay derating curves

## Fuse Holders Contacts Kit Specification

Fuse Holders Contacts Kit are delivered with NO, NC contact

Connection: Faston lugs 2.8 X 0.5 mm

Rated insulation voltage: 250VAC

Rated operational current following IEC 60947-5 & -1

Utilization category AC15: 4A/24V, 4A/48V, 3A/127V, 2.5A/240V

Utilization category DC13: 3A/24V, 1A/48V, 0.2A/127V, 0.1A/240V

Minimum operational current and voltage:

(For contact kit reference according to product rating see Table 4)

Contact kit Mersen Y227928A, for fuse size 14x51, or,

Contact kit Mersen G227959A for fuse size 22x58.

1mA/4V AC or DC

Contact kit Mersen E227612A, for fuse size 27x60

100mA/20V AC or DC

## Mains Network Measurements

All network measurements are calculated over a full mains cycle, but internally updated every half-cycle. For this reason, power control and alarms all run at the mains half-cycle rate. The calculations are based on waveform samples taken at a rate of 20kHz. The phase voltage referred to is the line voltage referenced to input potential.

The parameters below are directly derived from measurements for each phase.

Accuracy (20 to 25°C)

Line frequency (F):	±0.02Hz
Line RMS voltage (V <sub>line</sub> ):	±2% of Nominal V <sub>line</sub> .
Load RMS voltage (V):	±2% of Nominal V for voltage readings >1% of Nominal V. Unspecified for readings lower than 1%V <sub>nom</sub> .
Load current (I <sub>RMS</sub> ):	±2% of Nominal I <sub>RMS</sub> for current readings >3.3% of Nominal I <sub>RMS</sub> . Unspecified for readings ≤ 3.3% of Nominal. I <sub>RMS</sub> .
Load RMS voltage squared (V <sub>sq</sub> ):	±2% of (Nominal V) <sup>2</sup>
Thyristor RMS current squared (I <sub>sq</sub> ):	±2% of (Nominal I) <sup>2</sup>
Frequency resolution	0.1 Hz
Measurement resolution	11 bits of Nominal value
Measurement drift with ambient temp.	<0.02% of reading / °C

Further parameters (Z, IsqBurst, and Vsq Burst) are derived from the above, for the network (if relevant).

**WARNING**

**UNINTENDED EQUIPMENT OPERATION**

- Nominal current of product must be set between 25% & 100% of maximum current.

**Failure to follow these instructions can result in death, serious injury or equipment damage.**







Scan for local contents

## Eurotherm Ltd

Faraday Close  
Durrington  
Worthing  
West Sussex  
BN13 3PL  
Phone: +44 (0)1903 268500  
[www.eurotherm.co.uk](http://www.eurotherm.co.uk)

As standards, specifications, and designs change from time to time, please ask for confirmation of the information given in this publication.

© 2019 Eurotherm Limited. All Rights Reserved.

HA033173 Issue 3  
(CN37358)

